



SOFTWARE VERSION v1.3.2

WWW.PRG.COM

MBOX[®] PLAYER

USER MANUAL (rev. F)

AutoPar®, Bad Boy®, Best Boy®, Followspot Controller™, Mbox®, Mini Node™, Nocturne®, Series 400®, ReNEW®, Super Node™, UV Bullet™, V476®, V676®, Virtuoso®, and White Light Bullet™, are trademarks of Production Resource Group, LLC, registered in the U.S. and other countries.

Mac®, QuickTime® and FireWire® are registered trademarks of Apple Computer, Inc.

Mbox uses the Hap family of codecs. Hap was created by Tom Butterworth and VidVox LLC.

Mbox makes use of the Syphon Framework. Syphon was created by bangnoise (Tom Butterworth) & vade (Anton Marini).

All other brand names which may be mentioned in this manual are trademarks or registered trademarks of their respective companies.

This manual is for informational use only and is subject to change without notice. Please check www.prg.com for the latest version. PRG assumes no responsibility or liability for any claims resulting from errors or inaccuracies that may appear in this manual.

Mbox® Player v1.3.2 User Manual
Version as of: November 16, 2021 rev F
PRG part number: 02.9800.0007.132

Production Resource Group
Dallas Office
8617 Ambassador Row, Suite 120
Dallas, Texas 75247
www.prg.com

TABLE OF CONTENTS

Chapter 1. Overview

General Overview

Features	4
Concepts of Operation	5

User Interface

Overview	6
Clip List	7
Programming Area	7
Show Output Window	8
Syphon Output	8

Chapter 2. Installation

Getting Started

Before Starting	10
Installing Mbox Player Software	10
Suggested Hardware Configurations	10
Installation	11
Licensing Mbox Player Software	13
Launching Mbox Player	16
Adding Content	17

Playing Clips

Quickstart	18
Clip List Row Highlight Color	20

Chapter 3. Configuration

Clip Formatting Guidelines

File Type Specifications	22
Content Management	23
Content File Naming	24
Adding Content	24

Application Windows

Overview	25
Main User Interface Window	26
Clip List	26
Preview Bus	27
Program Bus	30
Action/Override Area	31
Preferences Window	32

Connected Display and Fullscreen Mode Interactions

Overview	34
----------------	----

Enhancing Mbox Player Performance

Recommended Hardware Practices	36
Recommended OS Setup	36
Mbox Player Setup	36

Chapter 4. Operation

Showfile Management

Overview	38
Save/Open/New Showfile	38

Clip Management

Overview	39
Adding Content to the Computer	39
Adding Content to the Clip List	39
Adding Sidecar Audio to Clips in the Clip List	40
Removing Clips from the Clip List	41
Copying and Pasting Clips in the Clip List	41
Replacing Content in the Clip List	41
Reordering Clips in the Clip List	43
Missing Content in the Clip List	44

End-Of-Clip Actions

Overview	45
Loop, Freeze, or Link	45
End-Of-Clip Action Priorities	46

Preview Bus - Adjusting Clip Properties

Overview	47
Loading a Clip into the Preview Bus	47
Adjusting Clip Properties	48
Media Tab	48
Geometry Tab.....	49
Color Tab.....	50
Playback Controls	50
Audio Playback	51
Keyboard Shortcuts in Preview Bus	51

Program Bus - Show Output

Overview	52
Adjusting Clip Properties	52
Keyboard Shortcuts in Program Bus	52

Manual Overrides

Overview	53
Take and Kill Timing	53
Goto In, 10, 20, 30	54
End-Of-Clip Overrides	54

Remote Control Via OSC

Overview	55
Configuration	55
Supported OSC Commands	55

Tips And Tricks

Helpful Hints When Using Mbox Player	57
--	----

Audio File Playback and Output

Overview	58
Embedded Audio Tracks (in Movie Clips)	58
Standalone and Sidecar Audio Files	58
Playback Duration of Audio	59
Audio Output Volume Control	59
Selecting an Audio Output Device	60

Chapter 5. Mbox Player Sync

Mbox Player Sync Application

Playback Synchronization	62
Mbox Player Sync Application User Interface	62

Configuration

Overview	63
Network Interface	63
Sync Group	63
Delay	64

Triggering Playback Remotely

Configuration	64
Triggering Playback	64

Chapter 6. Content Creation and Utilities

Creating Custom Content

Movies	66
File Extension.....	66
Codec	66
Compression (Bitrate).....	67
Frame Rate	67
Resolution	68
Alpha Channel in Movies	68
ProRes 4444 and Hap Alpha Codecs	68
Still Images	69
Audio	69
Text Files	70
Applications for Content Creation	70

Media Utility Applications

Mbox File Converter	71
---------------------------	----

Appendix A. Networking for Mbox

Mbox Networking Guidelines

Concepts	74
Subnet Masking Basics	74
Routing Ethernet Communications	75
Standard Control Protocols	77
Art-Net	77
sACN.....	77
KiNET	77

Index

Index	80
-------------	----



REVISION HISTORY

This manual has been revised as follows:

Version	Release Date	Notes
1.0 (revA)	February 23, 2018	Initial Release
1.1 (revB)	January 9, 2019	v1.1 release
1.2 (revC)	July 12, 2019	v1.2 release, new soft-licensing (QLM)
1.2.1 (revD)	October 28, 2019	v1.2.1 release (bug-fix only)
1.3 (revE)	December 18, 2019	v1.3 release: auto-sidecar, volume 2x, hue & sat, end-of-clip warn time pref
1.3.2 (revF)	November 16, 2021	v1.3.2 release, AVF Batch Converter



INTRODUCTION

About This Guide

This guide is provided to explain the features and operation of the Mbox Player software in detail.

Important Note About Control

The Mbox Player software is designed to work without external controllers. All user interface elements required to configure the application and to create and recall clips is built into the application.

Important Note About Show File Compatibility

The Mbox Player v1.3.2 release uses the updated fixture and showfile format introduced in Mbox Player 1.3. These updated formats accommodate the addition of the hue and saturation parameters, and to allow the volume control to go to 200%.

These changes mean that show files created with Mbox Player v1.3.2 are not compatible with versions of the Mbox Player application prior to v1.3. Older versions of Mbox Player will display an error message when loading an incompatible show file and will require a new show file to be started.

Show files created by older versions of Mbox Player can be opened and used with Mbox Player v1.3.2. However the hue and saturation parameters will not be available for any clips added to the clip list, and the volume default for any existing clips will be 200%. To avoid the limitations for the hue and saturation parameters and the volume parameter, you must start a new show using Mbox Player 1.3.2 and then add clips as required.

Customer Service

For technical assistance, contact the nearest PRG office. Contact information for all PRG offices can be found on our website at: www.prg.com

For Mbox support, please contact: mboxsupport@prg.com

For additional resources and documentation, please visit our website at: www.prg.com

Notes



1.

OVERVIEW

This chapter provides an overview of Mbox Player features and operation

- + **GENERAL OVERVIEW**
- + **USER INTERFACE**



GENERAL OVERVIEW

Features

The Mbox Player application is designed to be a simplified platform for the creation and playback of movies and still images. Mbox Player provides tools for the adjustment of the visual properties of the content and for the sequencing of that content with cuts, crossfades, or delays when transitioning between pieces of content.

Mbox Player is built using the same playback and rendering engine as the rest of the Mbox media server family. This gives Player a solid foundation built upon the ease-of-use, flexibility, and power of the Mbox product.

The Mbox Player software is programmed and operated using a single computer having one video output for the programming interface and a second output for the visual content. The programming interface uses the industry-standard concept of preview and program, giving the operator the ability to cue up the next piece of content and to view that content and make changes to its properties while another piece of content plays.

Movie and still image content is easy to add to Mbox Player's Clip List for subsequent playback. The properties for each piece of content can be modified and the modified properties are stored with the content for recall at a later time.

The Mbox Player software runs on an Apple® Mac® computer. All movies and still images can be stored on any storage media connected to the computer, allowing for simple, flexible access to any file.

Mbox Player Software Features

- + Preview and Program arrangement for adjusting and previewing upcoming content while active content plays.
- + A wide range of adjustable properties that affect the look or composition of visual content, including: playspeed, in and out points, scale, position, cropping, color, and audio volume.
- + Manual and sequenced clip recall. Selectable loop, link, and freeze when clip reaches the end.
- + Adjustable-rate cut, crossfade, and delay transitions when moving between clips.
- + Simple output configuration. One output automatically configured to the connected display device, up to 4K resolution. (Output resolution may be limited by the capability of the computer hardware and/or the connected displays devices.)
- + Playback of movie and still image content up to 4K UHD. (Actual playback resolution may be limited by the capability of the computer hardware.)
- + Playback of audio embedded in movies, side-car audio, and stand-alone audio files.

Concepts of Operation

Basic Function

The basic function of Mbox Player is to play back content - movie clips or still images - during a visual production. The resulting imagery is output from the Mbox Player computer to a display device such as a projector, LED wall, or LCD screen. Adjustable parameters allow visual aspects of the content to be stored in advance or manipulated on the fly. The ability to make visual adjustments to the content on the playback device eliminates the need to modify the source content, which can save time onsite. And the ability to control the crossfade method and timing between sequenced content allows the show to transition in precisely the right manner.

Control

Mbox Player provides its own user interface for configuration and control. No external console or computer is required. The interface allows clips (movies or stills) to be added to a show file in sequential order. Clips can be loaded into the preview bus and their properties modified to achieve the desired visual look. The manner of transition from one clip to the next can be specified. Clips are then loaded into the program bus for output.

Primary Components

A typical Mbox Player system is made up of a computer with two different video display devices. When connected to the computer one display acts as the user interface and the other is used for show output. The following simplified diagram illustrates how these components work together:

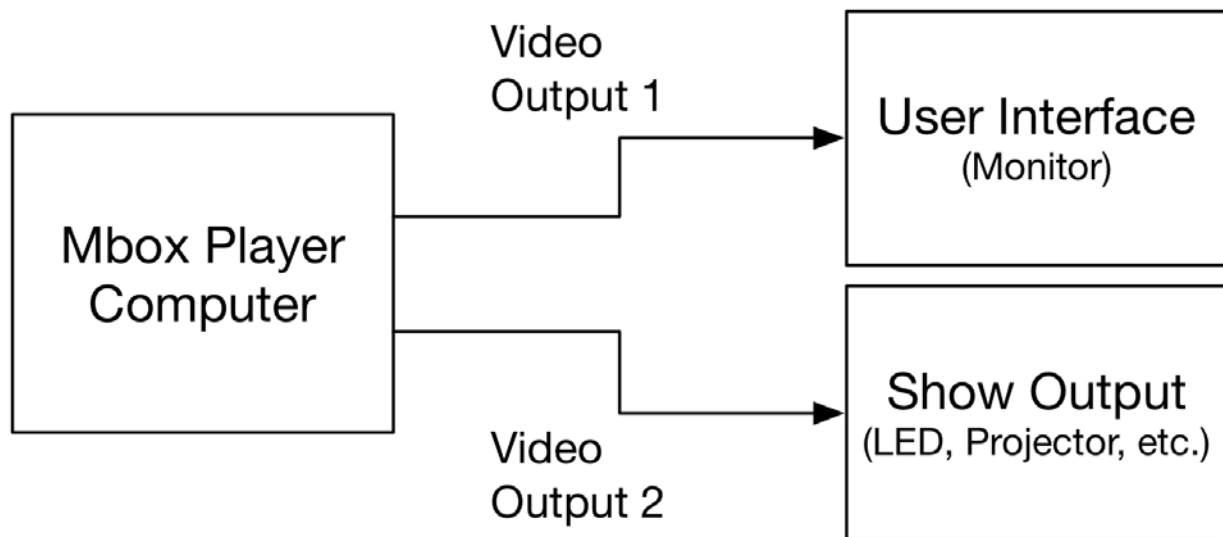

While Mbox Player's hardware requirements are not as stringent as those for the other Mbox media server software products, Player still requires a suitable Mac computer to achieve desired performance levels. The following items should be considered:

- + Operating System: Use Mac OS X 10.10 Yosemite or newer.
- + Video Card (GPU): Better GPUs will allow for higher content/output resolutions without performance issues.
- + Hard Drive Configuration: SSDs or flash storage will provide the best results.
- + Processor Type, Number of Cores, and Speed: Player requires an Intel 64-bit processor (Intel Core 2 or better). For best results, the processor should have at least two cores, running at a speed of 2.0 GHz or better.

USER INTERFACE

Overview

In order to get the most from Mbox Player, it is important to first understand the overall concept of the software. Mbox Player is intended to be used for simple clip sequencing and playback. As such, the user interface is streamlined as much as possible. The application has two windows: the main user interface window and the output window. The user interface window is used for configuration and control tasks and the output window for the actual show output of visual content. The Mbox Player software is intended to be used on a computer having two connected displays - the first being a local monitor for the main user interface, and the second being the show output device - e.g. a monitor, projector, or LED wall.

Note: The Mbox Player application can be used in Window mode with only one monitor for programming purposes. However a second video output must be connected to the computer for fullscreen output in show situations.

There are two main areas of Player's user interface: the clip list at the top of the window and the programming area located below.

Content (movies, still images, or text files) is added to the clip list and can be arranged in the desired order for playback. Clips can then be loaded for preview or playback, at which point their properties become editable in the programming area. The programming area itself is split into three parts, the preview bus, the program bus, and the area used to apply transition actions or overrides to clips when Take or Kill buttons are pressed.

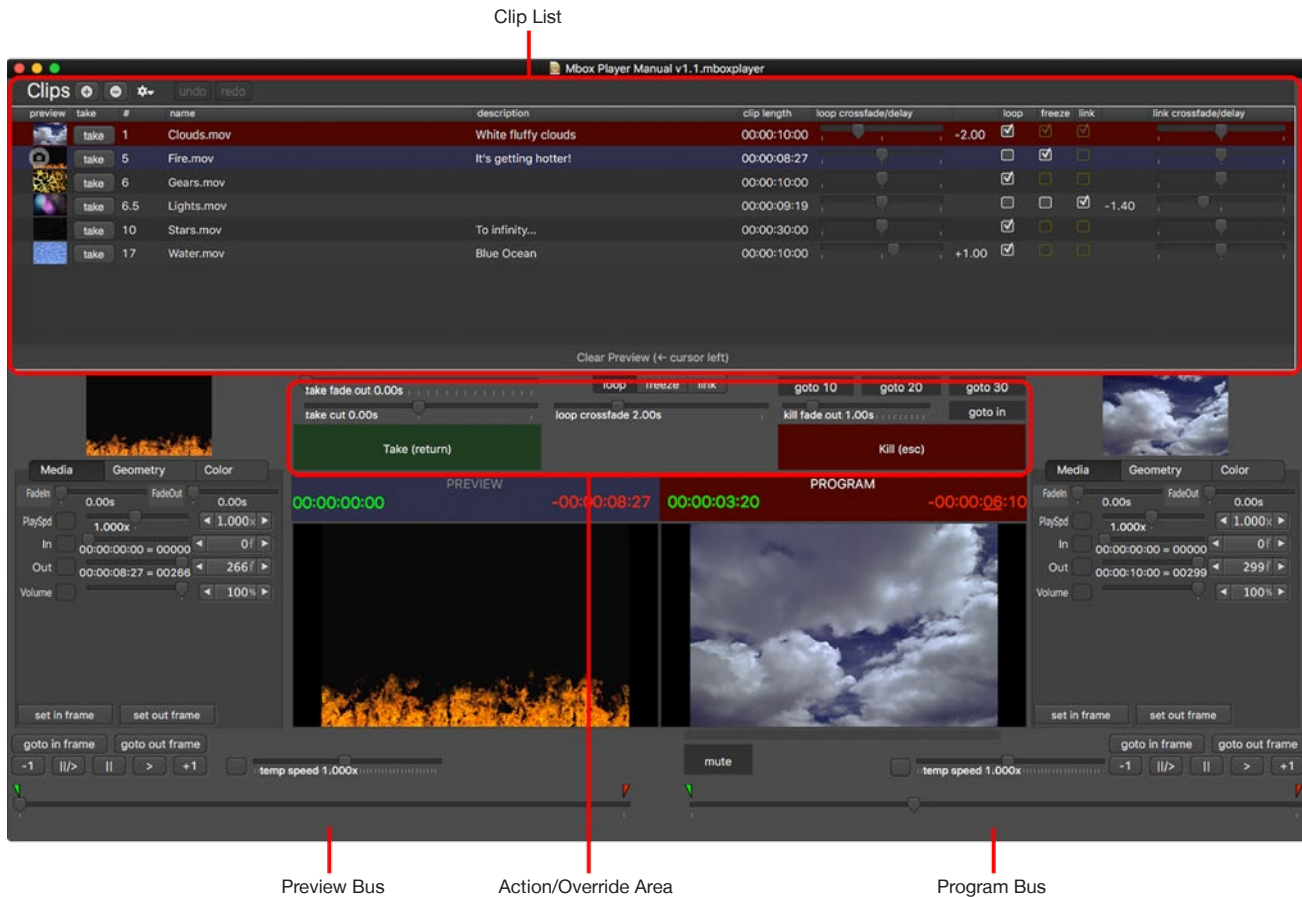



Clip List

The clip list area of Mbox Player's main window displays the clips that have been added to the show, as well as several properties that dictate how the show will transition from one clip to the next. The clip list is organized with one row per clip and the organization of a typical show will move from the first clip in the list to the last.

Clips can be added to the clip list using the "+" button found at the top of the list. Clips added to the list will always show the file name, a thumbnail image and the overall length of the clip. Optional information - a numerical reference and a description - can be added for each clip if desired.

Each clip also has a set of controls that determine what action will be taken when playback reaches the end-of-clip state - will it loop, freeze, or link to the next clip? - and the timing applied to loops and links. For more information on end-of-clip actions and transitions refer to "[End-Of-Clip Actions](#)" on page 45.

Clips can be reordered in the clip list by clicking and dragging them to a different position in the list. Clips can be deleted by clicking the "-" button at the top of the list. A clip action menu can be accessed by right-clicking on a clip or by clicking on the gear icon to the right of the "-" button. The options in this menu allow clips in the list to be duplicated, revealed in the Finder, or relocated/replaced if desired.

Note: The clip that is currently loaded into the program bus cannot be deleted.

Programming Area

The majority of time spent configuring the look of the content used in an Mbox Player show will take place in the programming area below the clip list. The programming area performs three important functions with regard to adjusting and displaying clips:

- + Parameter adjustment controls for both the preview and program buses allow various properties of the loaded clip to be adjusted before playback (in the case of the preview bus) or during playback (in the case of the program bus).
- + Clip viewer panes provide a reduced-size preview of the clips in the preview and program buses. These panes show the result of any adjustments to a clip's properties and actual playback of the clip.
- + The buttons and sliders found above the preview and program panes are used to perform actions related to manually transitioning from one clip to another. The Take button is used to manually move a clip from preview to program bus. The Kill button is used to remove a clip from the program bus. And the other buttons and sliders can be used to override the end-of-clip action and transition timing for the clip in the program bus.

Preview and Program Buses

The preview and program buses are virtually identical in design, with each having the same controls for adjustment of clip properties. Both buses support the playback of the clip that is loaded into them, with the main difference between the buses being that the preview is only visible on Mbox Player's main user interface window, while the program is also sent to the output window.

Following standard video switching conventions, clips are first loaded into the preview bus. Pressing the Take button will cause the clip that is loaded into the preview bus to be "taken," i.e. moved from the preview bus into the program bus and therefore visible on the show output. Depending on the end-of-clip action assigned to a clip, the next clip in the list may or may not be automatically loaded into the preview bus when the Take button is pressed.

CAUTION! When adjusting the properties of a clip that is loaded into the program bus, those adjustments will be immediately visible on the show output of the Mbox Player computer!

Show Output Window

Mbox Player's show output window always shows the clip that is loaded into the program bus. Rather than being shown at a reduced size (as in the program bus preview pane) the output window always shows clips at full size.

The show output window has two possible states: as a movable window or as a fullscreen view on the second video output of the Player computer. The first state is referred to as "Window mode" and the second state as "Fullscreen mode."

In show situations, Mbox Player requires the computer to have a second video output for use as the show output. Otherwise, it is not possible to enter Fullscreen mode and there will be no fullscreen show output.

If the Player application is launched on a computer with only one connected display device, the application automatically enters Window mode with both the user interface window and show output window on the same display. If the Player application is launched on a computer with two connected display devices, the application automatically enters Fullscreen mode and the user interface window will be on the first display and the show output will be on the second display (in Fullscreen mode).

If a second display device is connected to the computer, the [⌘F] keyboard combination can be used to toggle the show output in and out of Fullscreen mode. But if no second display device is connected, attempting to enter Fullscreen mode will cause the output window to disappear.

Syphon Output

Mbox Player can also use Syphon to output video to other Syphon-aware applications on the same computer (e.g. MadMapper). In this way, Mbox Player's show output can be used as an input to the other application, perhaps for further manipulation, 3D mapping, effects, etc.

The Syphon output from Mbox Player works automatically. The Mbox Player application creates and advertises its Syphon source, making it available to other applications. Simply launch the other application, look for Syphon sources, then select the desired source.

Mbox Player creates only one Syphon source for the show output.

Note: Mbox Player does not have Syphon inputs.



2.

INSTALLATION

This chapter provides instructions for installing the Mbox Player software and launching the application for the first time.

- + [GETTING STARTED](#)
- + [PLAYING BACK VIDEO QUICKSTART](#)



GETTING STARTED

Before Starting

It is strongly recommended that the Mbox Player software be installed and tested on the computer before purchasing a license!

Mbox Player requires macOS 10.10 or greater to be installed on the computer and a minimum of 50MB on the computer's boot drive with additional space for content. **The user who installs and runs Mbox Player must have Admin rights on the computer.**

Note on Gatekeeper (for OS X 10.10 - 12)

The Mbox Player application and installers have been code-signed and notarized by PRG to ensure they are both valid and have not been tampered with since their creation. Since the Player application cannot be delivered by way of the Mac App Store, make sure that the computer's Gatekeeper settings will allow applications from approved developers to be installed and launched.

To ensure a successful installation, open the System Preferences > Security & Privacy pref pane and click on the General tab. Then make sure that the setting for "Allow apps downloaded from:" has either the "App Store and identified developers" button or the "Anywhere" button pressed.

Download locations:

- + The latest versions of Mbox software, USB License key drivers, manuals, training movies, and demo content can be found at: <http://mbox.prg.com>
- + From that main page, scroll to the bottom of the page to find the additional links for Mbox Player, manuals, etc.

Installing Mbox Player Software

Note: The software installation sections below only apply to the retail version of the Mbox Player software, not the rental version.

Overview

The Mbox Player installer will place files in several places on the computer. The user that installs the software must have Admin rights to install software on the computer (with password authentication).

- + The Mbox Player software will be stored in the /Applications/Mbox Player folder.
- + Utility applications and scripts will be stored in the /Applications/Mbox v4 Utilities folder.
- + Support and preference files will be placed into the ~/Library/Application Support and ~/Library/Preferences folders.

Content for Mbox Player can be stored anywhere on the computer. However, for organizational purposes it may be best to put all content into one location. For best results, this location should be on a fast drive (SSD or flash).

Suggested Hardware Configurations

Mbox Player performance options:

- + **Highest performance** - Apple iMac Pro (2017) with one external video output adapter (as required) for connection to show output display device, or Apple Mac Pro (2019) with SSD/flash for content, upgraded GPU, 16GB+ RAM, two external video output adapters (as required) for connection to local monitor and show output display device.

- + **Medium performance** - Apple iMac with quad-core i7 processor, flash drive for OS plus separate Thunderbolt drive for content (SSD recommended), AMD Radeon Pro graphics card, 16GB+ RAM, external video output adapter for connection to show output display device. Apple Mac Pro (2013) with SSD/flash for content, D500 GPU, 16GB+ RAM, two external video output adapters (as required) for connection to local monitor and show output display device.
- + **Portable system** - Apple MacBook Pro or Mac Mini with quad-core processor, flash, SSD, or fusion drive for OS and content, optional separate drive for content (Thunderbolt connection with SSD recommended), 8GB+ RAM, external video output adapter for connection to show output display device.

Mbox computer minimum requirements:

- + Mac OS X 10.10 operating system or newer (High Sierra thru Catalina are preferred)
- + Intel Core 2 processor (64-bit), 8GB RAM

GPU hardware guidelines:

- + Mbox Player exposes a defect in the ATI/AMD device drivers in OS X 10.10. For best performance with Mbox Player when using an AMD GPU, use OS X 10.11 or better. There are no known issues with Nvidia GPUs.

Installation

To Install Mbox Player:

- Step 1. Download and unzip the latest installer disk image from the link noted on the previous page.
- Step 2. Make sure that no other Mbox-related applications are running, then open the disk image and double click on the package to launch the installer.

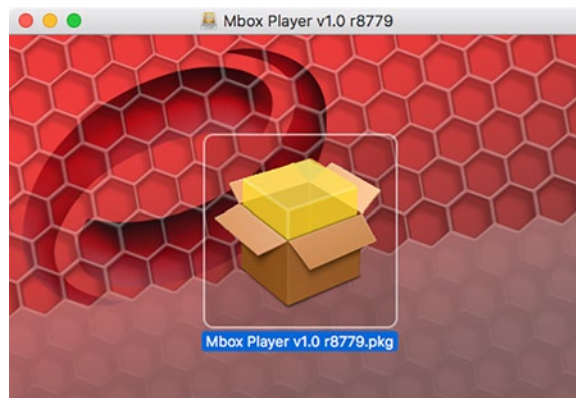

- Step 3. Read the installation notes, then press the Continue button.

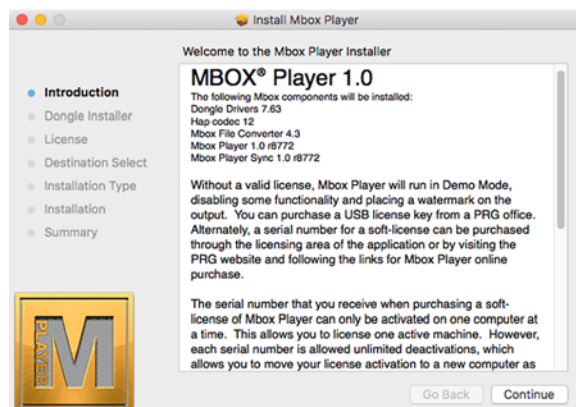

Step 4. The installer will ask whether it should install or update the drivers for the USB license key (i.e. the “Dongle Drivers”). If a USB license key is being used, make sure to install or update the drivers, otherwise they need not be installed. If a USB license key is purchased at a later date, the drivers can be installed without having to re-run the entire installer -> go to /Applications/Mbox v4 Utilities/Mbox Dongle Drivers and run the desired command to install/uninstall the drivers.

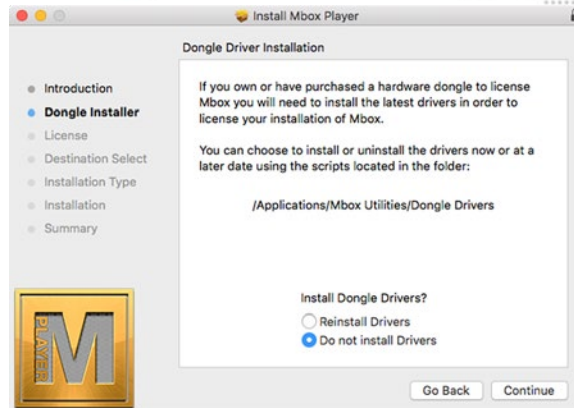

Step 5. Read the Software License Agreement, press the Continue and Agree buttons to agree to the legal terms, then press the Install button to begin the installation.

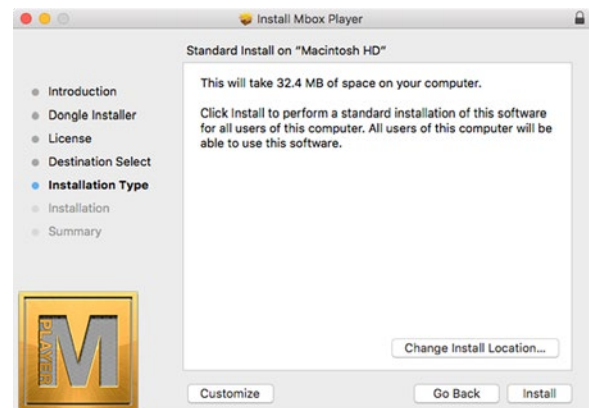
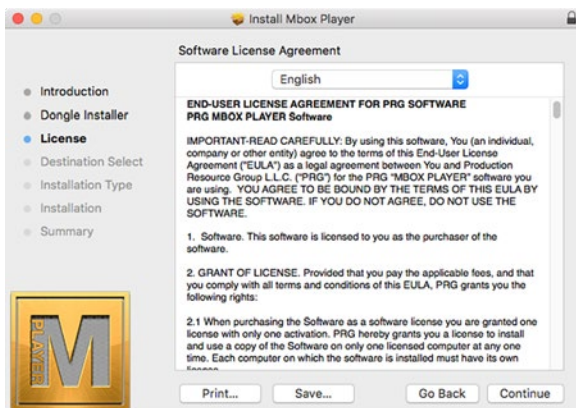

Step 6. In order to install the software, the installer will ask for the computer’s current user name and password. The user must be an Admin user of the computer for the install to complete.



Step 7. The installer will copy the necessary files onto the computer and then indicate success when the process is finished. When finished, the installer can be quit and the Mbox Player installer disk image can be ejected from the computer.

Licensing Mbox Player Software

Hardware USB License Key (Dongle)

When the Mbox Player software is installed, the installer provides the option to install the USB license key drivers as well. If a USB license key isn't being used, the drivers don't need to be installed. If a USB license key is purchased at a later time, the drivers can be downloaded from the link noted on page 10 and then installed. Once the drivers are installed, Mbox Player will recognize the USB license key.

If the Mbox Player application fails to recognize the USB license key at any point after the drivers are installed, please contact mboxsupport@prg.com for assistance.

Soft-license (EWS/eSellerate or QLM) Activation

CAUTION! You must install the Mbox Player software before attempting to activate a soft-license!

A soft-license for Mbox Player can be purchased online through the Mbox Player web page. Starting with Mbox Player v1.2, the EWS (eSellerate) licensing scheme has been replaced by the QLM licensing scheme. Previously purchased EWS licenses will continue to work, but new soft-licenses will all use the QLM scheme. An EWS activation key will start with "PRGMBP", a QLM key will start with "ANQK".

WARNING!! The soft-license places restrictions on the number of concurrent activations when using the license. The USB key license can be more flexible. Make sure the soft-license is the best option before continuing! Please contact mboxsupport@prg.com with any questions before purchasing.

When a soft-license for Mbox Player is purchased online, an email with a receipt and an activation key will be sent to the purchaser. To apply the soft-license to an installation of Mbox Player, follow these steps:

- Step 1. Connect the computer to the internet and launch the Mbox Player application.
- Step 2. Click on the Mbox Player item in the menu bar at the top of the window and click on the Licensing item.

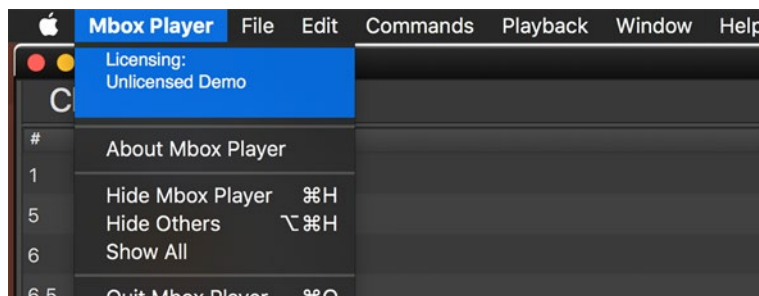

- Step 3. The Soft-License Controls window will appear.

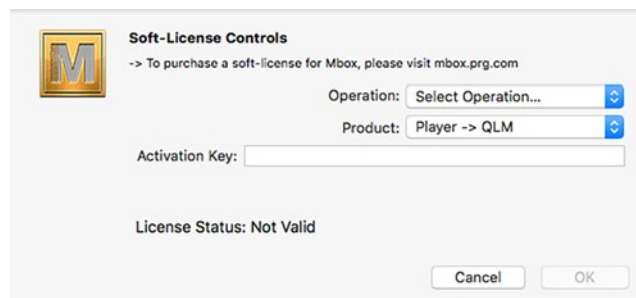

Step 4. Use the Product pop-up to select between a QLM or EWS soft-license as required.

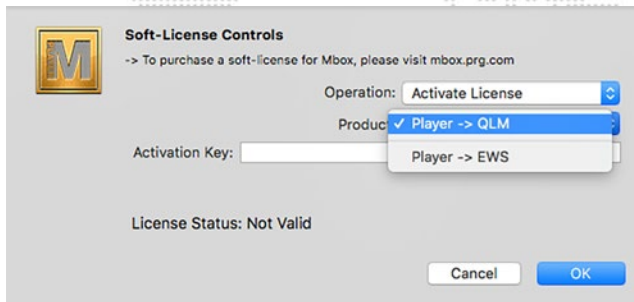

Step 5. Use the Operation pop-up to select the desired operation: Activate License.

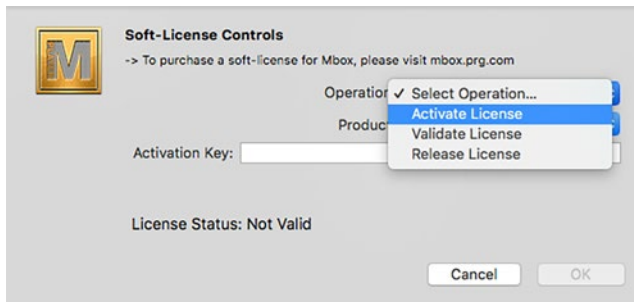

Step 6. If activating, enter the activation key in the corresponding field and press the OK button.

Step 7. If the soft-license activates successfully, then a confirmation will be displayed. If there is an error, this will be shown with an error code.

Note: For assistance with soft-licensing error codes, please contact mboxsupport@prg.com

After a soft-license has been successfully activated, both the Licensing item in the Mbox Player menu bar item, and also the Soft-License Controls window will show the activated key.

Soft-license Deactivation

To move a soft-license to a different computer, or to remove the soft-license from the computer follow these steps:

- Step 1. Connect the computer to the internet and launch the Mbox Player application.
- Step 2. Click on the Mbox Player item in the menu bar at the top of the main window and then click on the Licensing item.

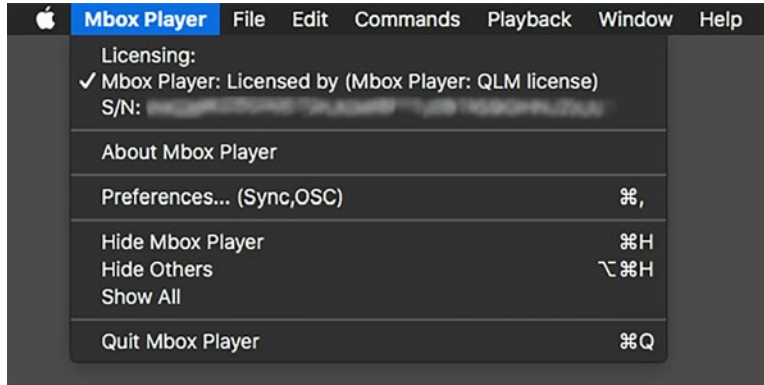

- Step 3. The Soft-License Controls window will appear, showing the currently activated key.
- Step 4. Click on the Product pop-up and select between a QLM or EWS soft-license as required.

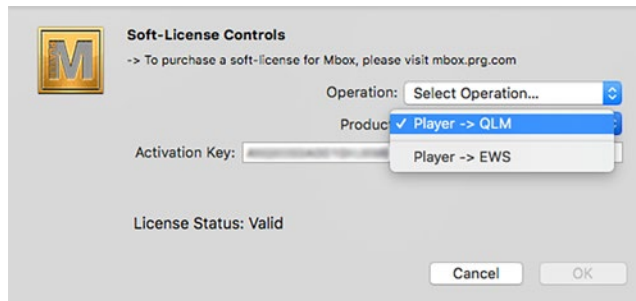

- Step 5. Click on the Operation pop-up to select the desired operation: Release License (i.e. deactivation).

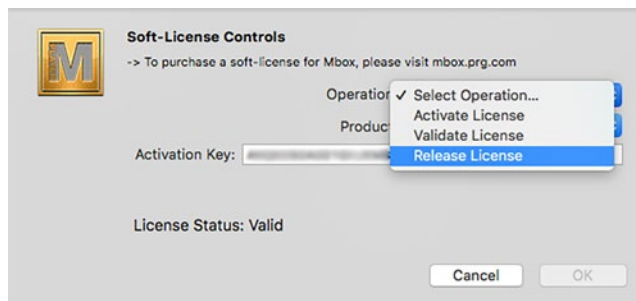

- Step 6. Do not proceed if unsure about the deactivation. If sure, click OK to deactivate the license on that computer.
- Step 7. If the deactivation completes successfully, a confirmation will be displayed. If there is an error, this will be shown with an error code.

Launching Mbox Player

When launched, the Mbox Player software will initially show a splash screen. During this time the software will scan for the content that is being used in the current show file. After a brief pause, the main application and output windows will appear.

Upon launch, depending on the number of video output devices connected to the computer, the software will start in either Fullscreen or Window mode.

- + If two or more video output devices are connected, Mbox Player will start in Fullscreen mode. Player's main user interface window will be shown on the first/primary display and the second display will be used for the show output.



Fullscreen Mode

- + If only one video output device is connected, Mbox Player will start in Window mode. Both the main user interface window and output window will be shown on the primary display.



Window Mode

When the Player application first launches, no clip will be loaded into the program bus, so the show output window/display will be black. This is normal; loading a clip into the program bus will cause it to appear on the show output.

In both Window and Fullscreen modes, the main user interface window will always be shown. But if only one video display device is connected to the computer, the show output window will disappear when entering Fullscreen mode. **Player must have two connected display devices to display the show output in Fullscreen mode!**

Refer to [“Main User Interface Window”](#) on page 26 for in-depth information about the main user interface window.

While Mbox Player is running, there are two important key combinations to be familiar with:

- + To toggle between Fullscreen or Window mode, press [⌘F].
- + To quit Mbox Player, press [⌘Q].

Adding Content

Use the following guidelines when adding content to the computer:

- + Copy the content onto the computer using standard Finder file copy methods
- + Content may be placed on any drive connected to the computer. For best performance, the drive used for content should be an SSD or flash drive.
- + Put all content onto a single drive rather than multiple drives. Spreading the content across multiple drives may make it harder to update or replace content in the future. Content should be placed into a single parent folder. This parent folder can have one or more sub-folders for organizational purposes.

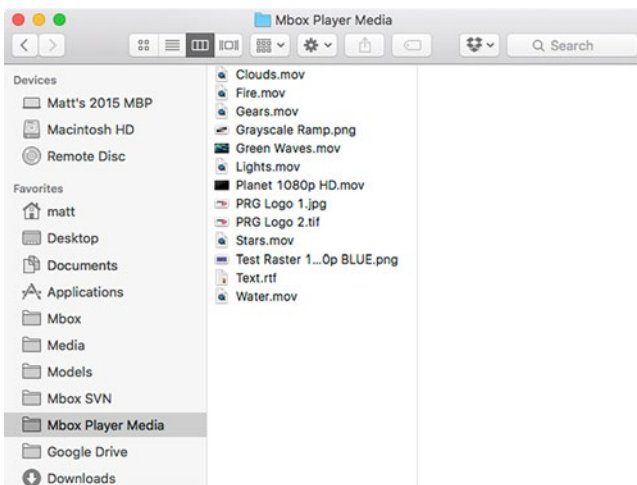

Content in single folder

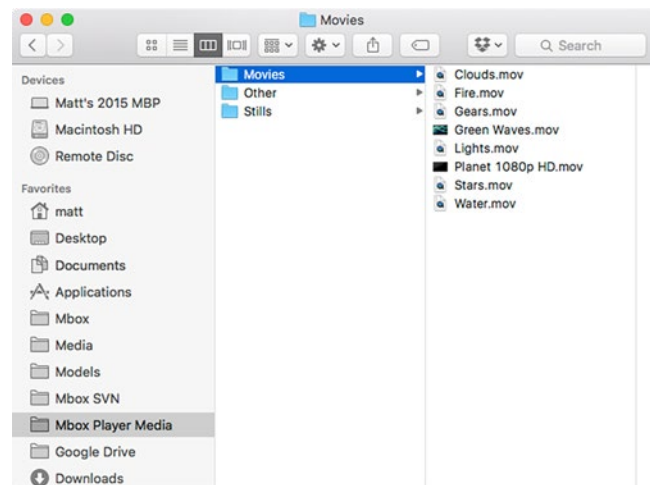

Content in sub-folders

- + Content for use with Mbox Player can be movies, still images, text files, or standalone audio files:
 - Movies must use the QuickTime format with either the .mov or .mp4 (with H.264 encoding) container types.
 - Player supports the following movie codecs: Photo-JPEG, Apple ProRes, H.264/mp4, Hap. **ProRes is recommended for best results.**
 - Movies can have embedded audio tracks. Up to eight channels of audio are supported. Whenever possible, embedded audio should use AAC encoding rather than LPCM encoding. Starting with Mbox Player 1.3, Player will make automatic sidecar audio files for movies having embedded audio with LPCM encoding.
 - Still images can use the JPEG, PNG, or TIFF format. Avoid making extremely large (>4K resolution) still images.
 - Text files must use the RTF format. Font style, color, and size settings are used in Player.
 - Standalone and sidecar audio files can use the AAC, AIF/AIFF, M4A, MP3, or WAV formats. Up to eight channels of audio are supported.
 - For more information on content, refer to [“Clip Formatting Guidelines”](#) on page 22 and [“Creating Custom Content”](#) on page 66.

PLAYING CLIPS

Quickstart

Once content has been added to the computer's drive, and a show output display device connected, clips can be played and viewed.

To immediately play a clip:

Step 1. Launch the Mbox Player application. Click on the "+" button at the top-left of the clip list.

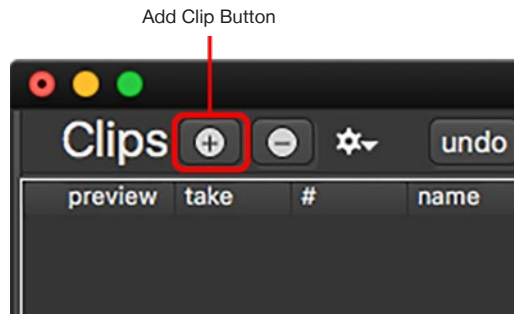

Step 2. In the file dialog window that opens, select a piece of content to add to the clip list, then press the Open button.

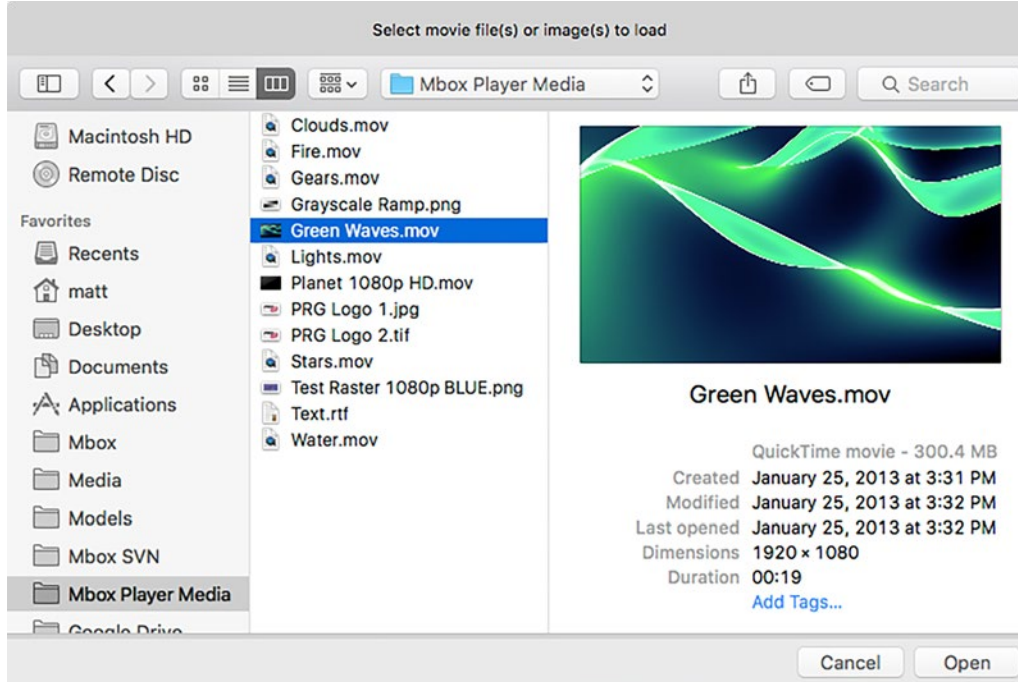

Note: Beginning with Mbox Player v1.1, content can be dragged from a Finder window and dropped onto the clip list. When dragging, a blue divider line will appear to indicate where in the clip list the dragged content will be dropped.

Step 3. When added to the clip list, the clip will automatically be selected. The clip's row in the clip list will have a blue background and the clip will be loaded into the preview bus.

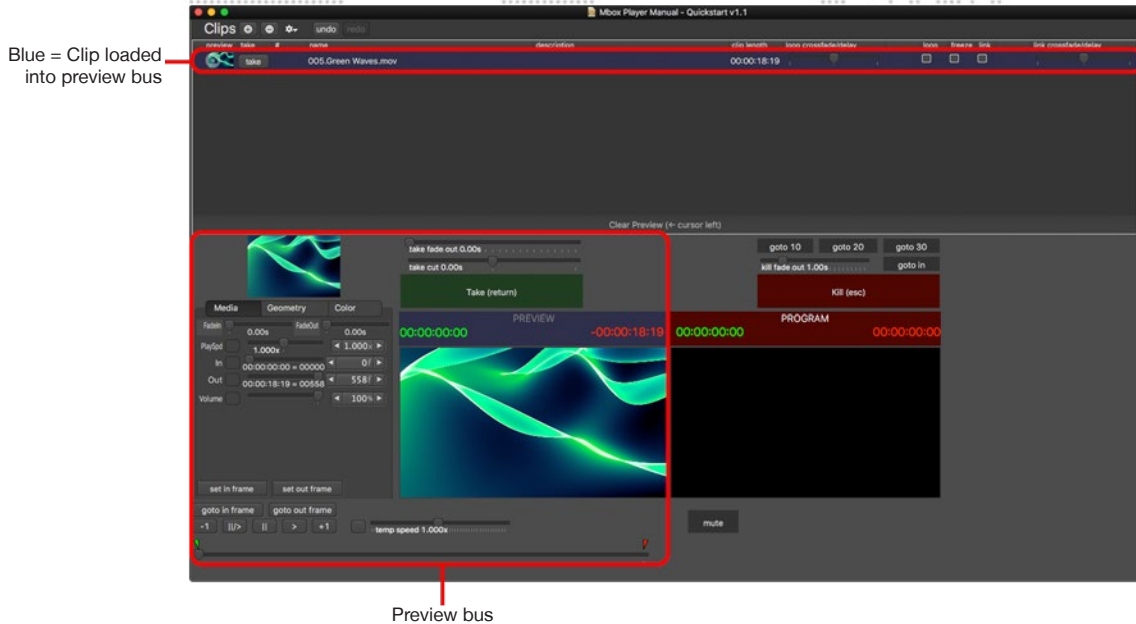

Step 4. Click on the Take button (or press [return] on the keyboard) to load the clip from the preview bus into the program bus. The clip will become visible on the show output and immediately start playing. And in the clip list, the clip's row will now have a red background.

Note: Beginning with Mbox Player v1.1, every clip has an immediate take button located on its row in the clip list. A clip can immediately be taken by clicking on its corresponding immediate take button.

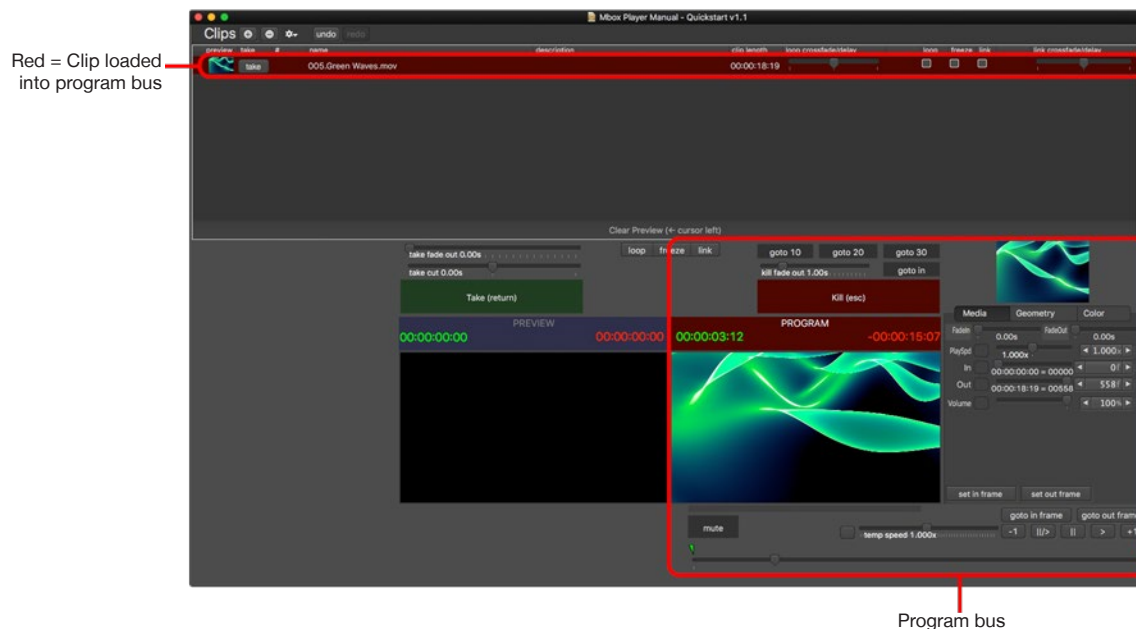

Note: In the case of this example, when the clip reaches its end, it will fade out and be returned to the preview bus. This is because it is the only clip in the show and because no end-of-clip action has been set. Refer to [“End-Of-Clip Actions”](#) on page 45 for more information on how to customize what happens when a clip reaches its end.

Clip List Row Highlight Color

The highlight color for a row in the clip list conveys different meanings depending on the color:

- + **Grey/Dark Grey** - This is the standard color for the clips rows, with the rows alternating between gray and a dark gray.

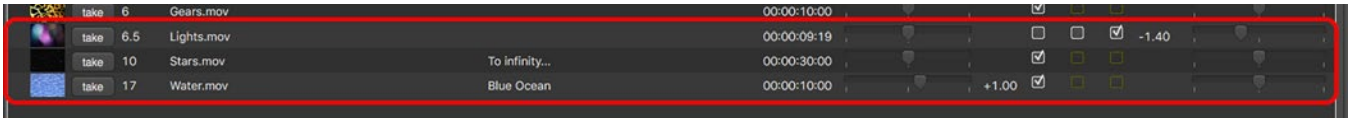

- + **Red** - A red highlight color indicates that the clip is currently loaded into the program bus and is visible on the Show output.

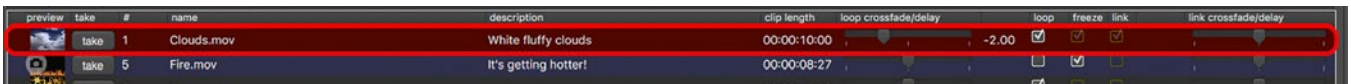

- + **Blue** - A blue highlight indicates that the clip is currently loaded into the preview bus.



- + **Green** - A green highlight indicates that the clip is currently being "Taken" i.e. the program bus is transitioning from the previous clip to this clip. This highlight will change to red once the clip has fully transitioned to the program bus.



- + **Blue/Green** - A blue and green highlight on the same row indicates that the clip is both loaded into the preview bus and being taken. This highlight will change to red once the clip has fully transitioned to the program bus.



The blue/green highlight is seen when a clip is being taken through a manual take, with a delay rather than a crossfade. Initially the next clip will have only a blue highlight to indicate that it is loaded into the preview bus for playback next. When the Take button is pressed, the next clip will receive the blue/green highlight to indicate that it is being taken but remains in the preview bus until the delay is complete.

Note: The blue/green highlight is only visible during the transition from one clip to another in the program bus. Therefore, the length of time that it is visible is dependent on the length of the transition time (delay time).

During long manual delays, it is possible to click on another clip in the clip list to select it to be loaded into the preview bus while the prior preview clip is waiting to be loaded into the program bus. When this situation arises, the current delayed transition is not stopped and will complete. But to indicate that one clip is being taken but another clip is now loaded into the preview bus, the two clips will have green highlighting and blue highlighting respectively. Once the transition is complete, the green clip will turn red, and the blue clip will stay blue.

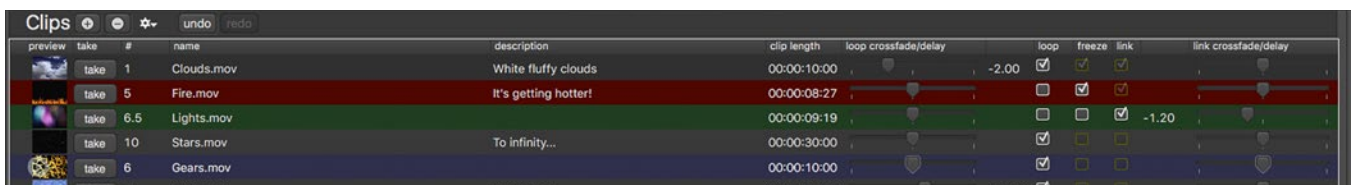



3.

CONFIGURATION

This chapter provides information regarding the initial configuration of Mbox Player.

- + [CLIP FORMATTING GUIDELINES](#)
- + [APPLICATION WINDOWS](#)
- + [CONNECTED DISPLAYS AND FULLSCREEN MODE INTERACTIONS](#)
- + [ENHANCING MBOX PLAYER PERFORMANCE](#)



CLIP FORMATTING GUIDELINES

File Type Specifications

The Mbox Player software uses Apple's AVFoundation® technology for clip playback. AVFoundation offers modern API's with better performance than older QuickTime technology. AVFoundation has limits to the file formats and movie codecs that it can play. The following file types are supported:

Still Image Files

PNG (.png), JPEG (.jpeg or .jpg), TIFF (.tiff or .tif) for still image files.

- + For still images with or without transparency, PNG is the best choice.
- + For still images not requiring transparency, JPEG is a good choice.
- + For still images with transparency, TIFF files can be used but may take longer to load due to their large file size.

Still image files should be formatted for screen output, using 72 dpi, rather than for print output at 300 dpi. For best performance, do not make any still image larger than a 4K resolution - 3840 x 2160.

Movie Files

Mbox Player continues to use the QuickTime container format (.mov) for most movie files but can also use the MPEG4 container format (.mp4) for H.264 movie files. Spatially-compressed codecs (ProRes or Photo-JPEG) will usually provide better playback results than temporally-compressed codecs like H.264.

- + **Apple ProRes** - The ProRes family of codecs includes five versions. ProRes Proxy has the lowest bitrate, but consequently the lowest quality. Light and Normal are the recommended codecs for movies. High Quality can be used if the resulting bitrate is not too high (250Mb/sec or lower). ProRes 4444+ may be used if transparency is required in the movie file, but as with ProRes HQ, keep the bitrate below 250Mb/sec if possible.

Note: All modern Mac computers can play ProRes movies. But unless the full ProRes codec is installed, the computer may be unable to encode ProRes files (e.g. when using the Mbox File Converter application).

- + **Photo JPEG** – Medium-High (60-80%). The quality of Photo-JPEG is not equal to that of the ProRes, but it typically has a lower bitrate and therefore can place a lighter load on the system if a lot of movies are being played.
- + **Hap** - The Hap family of codecs includes four versions: Hap, Hap Q, Hap Alpha, and Hap Q Alpha. The Hap codec, and especially Hap Q and Hap Q Alpha, trade off higher bitrates for lower CPU load, so keeping the bitrate at a reasonable level is important. The Hap codec does not need to be installed to play Hap movies with Mbox Player, but must be installed to encode Hap movies or to play them in other QuickTime-based applications.

IMPORTANT! Mbox Player can play Hap movies. But unless the Hap component is installed, the computer will be unable to play or encode Hap files (e.g. when playing movies in QuickTime or when using the Mbox File Converter application).

- + **H.264** - H.264 works with Mbox Player, and bitrates can be low for quite high-quality imagery. But because H.264 is temporally compressed, playspeed adjustments may lead to jerky playback and movie load times can be longer than with spatially compressed codec. This means that neither H.264 nor .mp4 are recommended.



Audio Files

Mbox Player supports audio playback of audio that is embedded in movie files and sidecar/standalone audio files. Movie files can have up to 8 channels of embedded audio, but embedded audio should use AAC encoding for the audio whenever possible. Starting with Mbox Player v1.3, Player makes “auto-sidecar” files for movies having embedded LPCM audio to allow for correct audio playback. Sidecar and standalone audio files can use the AAC, AIF/AIFF, M4A, MP3, or WAV audio formats and can also have up to 8 channels. Refer to [“Audio”](#) on page 69 for more information on formatting audio for Mbox Player.

IMPORTANT! The auto-sidecar files that Mbox Player makes automatically will be placed in the same folder as the associated movie file and will use the .caf file extension. Do not delete these files, or audio may not play!

Additional File Types

Mbox Player supports the use of Rich Text Format (.rtf) for displaying onscreen text. Refer to [“Text Files”](#) on page 70 for information on formatting RTF files.

Note: File extensions are not case-sensitive. For example, files with extension .JPG and .jpg are the same.

Recommended Practices

PNG and JPEG are recommended for creating still image content for use with Mbox Player. ProRes is the recommended codec for optimum movie playback, but care should be taken to choose the right level of ProRes to match quality and performance requirements. Mbox will play movies that use other QuickTime codecs - Photo-JPEG, Hap, and H.264 - where support has been added or the codec is compatible with AVFoundation. However, depending on the computer being used, Hap and H.264 movies may not load as quickly or play as smoothly as ProRes or Photo-JPEG movies.

For best results, all content should be created in a single, common format using an appropriate resolution, codec, and framerate. Avoid making abnormally large still image files; limit them to a 4K resolution or smaller. (Refer to [“Creating Custom Content”](#) on page 66 for more information)

Note: In this manual, “preferred movie codecs” refers to Apple ProRes, Hap, and Photo-JPEG. All other movie codecs are considered “non-preferred.”

Mbox Player will always automatically play audio from a movie that has embedded audio. If the audio in a movie file is not needed, the embedded audio tracks should be removed. To completely remove audio tracks from movies, use an application to re-render or export the movie without its audio tracks. One option is to drop the file onto the Mbox File Converter application, making sure the “copy audio” checkbox is not checked (see [“Mbox File Converter”](#) on page 71).

As is the case with all media playback software, Mbox Player’s overall playback performance can decrease as the resolution of its content files increases. Content up to and including 4K can be played, keeping in mind that higher-resolution files will often lead to lower performance than smaller files. The amount of compression used when creating a file will also affect performance. Given equal file resolutions, higher quality (lower compression) files may not play as well as higher compression (lower quality) files. Depending on the display device, high-resolution or low-compression files may not look better than lower-resolution, more highly-compressed files. For best results, try to find a compromise between quality and performance.

File Extensions

All content files used with Mbox Player must have a valid file extension! Files with no file extension or an incompatible file extension cannot be selected or dropped when adding content to the clip list.



Content Management

Mbox Player allows for flexibility in content storage, but when adding content files, it is recommended that a specific, organized folder structure be created. It is possible to have content all over the place on the computer, but it is far better to place all the content in one common location on a single connected drive.

Content can reside locally on the computer's internal boot drive or on any other internal or external drive connected to the computer.

- + Content should be stored on a fast drive (SSD or flash-based storage) for best performance. Use of fast external devices can provide a performance improvement, but slow external devices may result in poor playback.
- + If content is placed on an external drive, that drive must be connected to the computer before Mbox Player is launched.

When launched, the Player software opens the current showfile, checks the clip list, and then performs a scan to search for the clips that have been added to the clip list in the show. If the file for a clip is found in the same location that is stored in the clip list, then the clip will be playable. If the file is missing - has been moved, deleted, or renamed - Mbox Player will display a warning/error. (Refer to [“Missing Content in the Clip List”](#) on page 44)

Note: This check allows the locations of content files to be resolved at startup, therefore the actual location of a file has no effect on the time required to find or open it. However, it is still recommended that all content be kept in one location on a single drive, rather than in multiple locations on one or more drives.

Content File Naming

Content files do not need to follow any particular naming conventions. The folder(s) that content is stored in can have any name, and the content itself can have any name. However, some scheme of naming may help the content to be better organized. Unlike the Mbox media server software, folders and individual content files do not need to have numerical prefixes.

Adding Content

As noted on the previous page, content can be placed directly within the single, “parent” folder, or additional sub-folders can be placed within the parent folder and content organized inside of the sub-folders. The actual folder location does not matter.

- + A folder inside the ~/Documents folder is a good location for content if it will be stored on the computer's boot drive.
- + If using a secondary internal drive or an external drive, consider making a folder at the root of the drive and placing all content there.
- + Keeping all content organized in a single location or single folder makes management easier and allows the content and the showfile to be moved to another computer more easily. This single folder can have multiple sub-folders for better organization if desired.
- + Starting with Mbox Player v1.3, auto-sidecar audio files will be made when a movie clip with embedded LPCM audio encoding is added to the clip list. Auto-sidecar files are placed into the same folder as their associated movie files.

To add content to the computer, connect the drive that the content is stored on, then use the Finder as normal to drag and drop or copy and paste files from one location to another.

Note: Refer to [“Adding Content to the Clip List”](#) on page 39 for information on adding content to the clip list in Mbox Player.

APPLICATION WINDOWS

Overview

The Mbox Player application window allows the application's output to be viewed in either Window or Fullscreen mode on the connected display(s).

- + **Window** - While in Window mode, both Player's main user interface window and a separate window for the show output will be visible on the computer's primary/first display. In this mode, both window can be repositioned and the main window can be resized.
- + **Fullscreen** - While in Fullscreen mode, Player's main interface window will remain on the first display and if a second display is connected to the computer, the output window will resize and move to cover the entire screen of the second display.

Examples of the Window mode and Fullscreen mode views are shown below:



Window Mode



Fullscreen Mode

Main User Interface Window

Mbox Player's main user interface window has four areas, each being used for specific functionality within the application: Clip list, Preview bus, Program bus, and Action/Override area.

- + **Clip list** - content added to the show (i.e. clips) is shown here in sequential order for eventual playback. The displayed file name and preview thumbnail are non-editable properties, but other properties can be edited for organizational purposes or to modify what happens when the clip reaches the end.
- + **Preview bus** - clips are loaded into the preview bus as the first step before they are loaded into the program bus for display on the show output. While in the preview bus, various properties of the clip can be modified but are not visible on the show output. Changes to properties are automatically stored with the clip and recalled whenever the clip is loaded into the preview or program buses.
- + **Program bus** - the program bus is used when clips are displayed on the show output of the computer. Clips are "taken" from the preview bus and loaded into the program bus when the Take button is pressed. While in the program bus, various properties of the clip can be modified but these changes will be visible on the show output. Changes to properties are automatically stored with the clip and recalled whenever the clip is loaded into the preview or program buses.
- + **Action/Override area** - the buttons and sliders in this area are used to take or kill a clip, modify the default fade timing when the take or kill buttons are pressed, override a preprogrammed end-of-clip action, and to jump the movie in the program bus ahead to a predetermined point.

Clip List

All content for the current show must be added to the clip list before it can be loaded into either the preview or program buses for edits or playback. The clip list is essentially the cue list for the show and is often followed in sequential order (top to bottom) during the show.

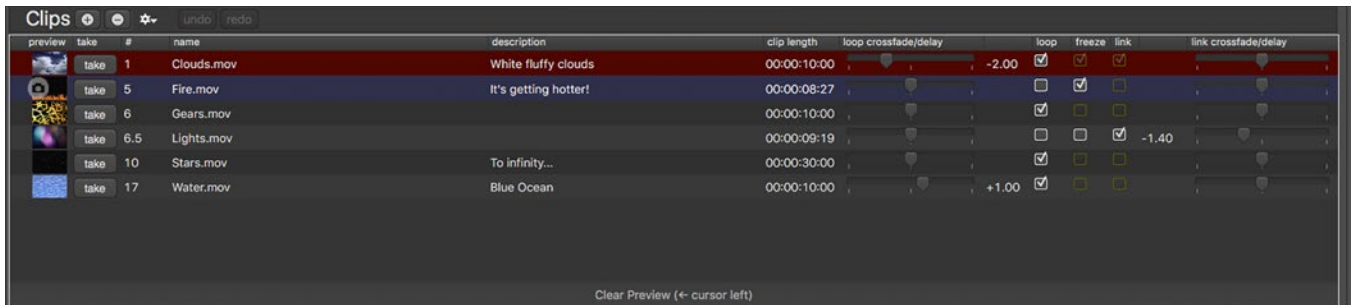

preview	take	#	name	description	clip length	loop crossfade/delay	loop	freeze	link	link crossfade/delay
	take	1	Clouds.mov	White fluffy clouds	00:00:10:00	-2.00	<input checked="" type="checkbox"/>	<input checked="" type="checkbox"/>	<input checked="" type="checkbox"/>	
	take	5	Fire.mov	It's getting hotter!	00:00:08:27		<input checked="" type="checkbox"/>	<input checked="" type="checkbox"/>	<input type="checkbox"/>	
	take	6	Gears.mov		00:00:10:00		<input checked="" type="checkbox"/>	<input type="checkbox"/>	<input type="checkbox"/>	
	take	6.5	Lights.mov		00:00:09:19		<input type="checkbox"/>	<input type="checkbox"/>	<input checked="" type="checkbox"/>	-1.40
	take	10	Stars.mov	To infinity...	00:00:30:00		<input checked="" type="checkbox"/>	<input type="checkbox"/>	<input type="checkbox"/>	
	take	17	Water.mov	Blue Ocean	00:00:10:00	+1.00	<input checked="" type="checkbox"/>	<input type="checkbox"/>	<input type="checkbox"/>	

The clip list's columns provide clip information and allow end-of-clip actions to be selected and modified:

- + **Preview** - a reduced size thumbnail of the clip is shown here. This thumbnail is automatically created when the clip is added, but can be updated at any time by clicking on the camera icon that appears beside the preview thumb whenever the clip is loaded into the preview bus.
- + **Take** - the immediate take button for each clip is located here. Pressing the button will cause the clip to be immediately taken, thereby replacing any clip already in the program bus. The manual take fade out and take crossfade or delay timing will be taken into account if this button is pressed.
- + **#** - this field can be used to add a numerical reference to a clip. The number used can range from 0 to 9999.99. Clip numbers do not need to be sequential. Beginning with Mbox Player v1.1, clips can be immediately loaded into the preview bus by typing their clip number on the keyboard or triggered by clip number using OSC.
- + **Name** - when a clip is added to the show, the default is to give the clip a name that is the actual file name. When the program bus is empty, clip names can be edited by double-clicking on the field, use [tab] or [return] to finish editing.

- + **Description** - an additional description for the clip can be entered here. When the program bus is empty, clip descriptions can be edited by double-clicking on the field, use [tab] or [return] to finish editing.
- + **Clip Length** - this column shows the length of the clip, from start to finish, taking into account the in and out frame values that are stored for the clip.
- + **Loop Crossfade/Delay** - this slider and the field to its left allows the end-of-clip loop timing to be adjusted. The slider is used to adjust the loop timing - default is a zero-time cut, to the left of default creates a crossfade, to the right of default creates a delay (i.e. a cut to black before the movie restarts). The field to the left of the slider shows the duration of the loop crossfade/delay in seconds, with a negative number indicating a crossfade and a positive number indicating a cut.

Note: The three end-of-clip action checkboxes - Loop, Freeze, and Link - have priorities. A Loop overrides a Freeze, and a Freeze overrides a Link. The override is indicated by dimming the overridden checkbox. While an overridden Freeze is always ignored, even if a Link is overridden, it will still be acted upon manually if the Take button is pressed.

- + **Loop** - if checked, the clip will loop when it reaches the end-of-clip state. The loop will follow the timing set by the Loop Crossfade/Delay slider.
- + **Freeze** - if checked and not overridden by a Loop, the clip will freeze when it reaches the end-of-clip state.
- + **Link** - if checked and not overridden by a Loop or Freeze, the clip will follow the timing set by the Link Crossfade/Delay slider and automatically transition to the next clip in the clip list.
- + **Link Crossfade/Delay** - this slider and the field to its left allows the end-of-clip link timing to be adjusted. The slider is used to adjust the link timing - default is a zero-time cut, to the left of default creates a crossfade, to the right of default creates a delay (i.e. a cut to black before the next clip starts). The field to the left of the slider shows the duration of the link crossfade/delay in seconds, with a negative number indicating a crossfade and a positive number indicating a cut.

Note: The columns in the clip list can be rearranged and some can be resized. Values in the #, Name, and Description columns can only be edited when no clip is loaded into the program bus (i.e. the Kill button has been pressed).

Preview Bus

The preview bus area on the bottom-left of the main window is used to view, play back, and adjust the properties of the clip loaded into the preview bus. The preview bus has three major components: clip properties, playback controls, and the live preview. Each of the three components has elements used to view and adjust the look and playback of the clip.

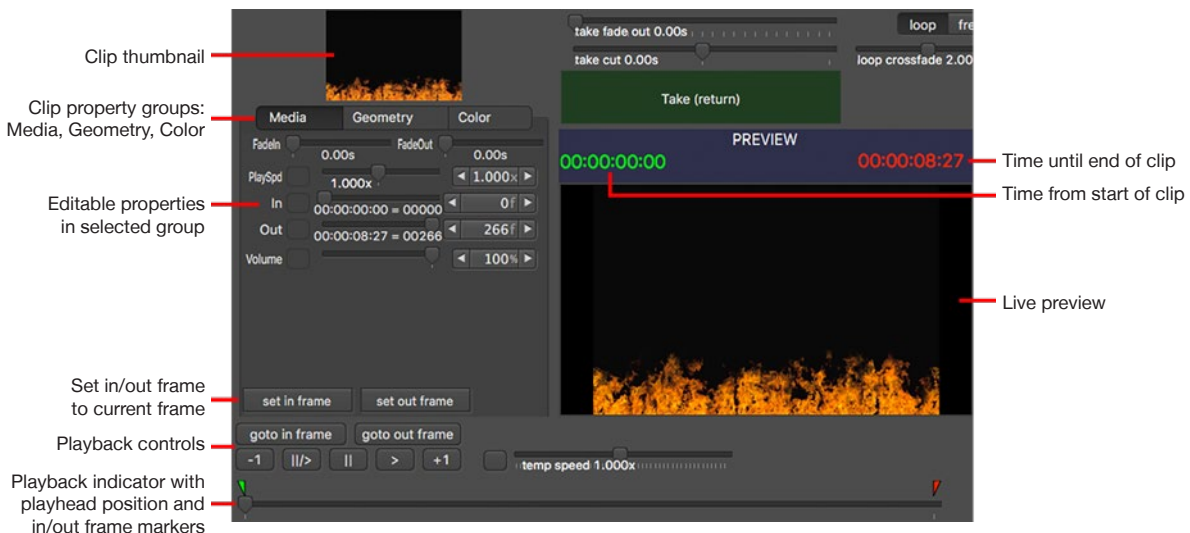

The left side of the preview bus area displays a thumbnail image of the clip - this is the same as the thumbnail image shown in the clip list. The editable properties for the clip are shown below the thumbnail, organized into three tabs:

+ Media

- Fade In/Out: controls fade up from black at the beginning of the clip and fade to black at the end of the clip. Range is from 0 to 5 seconds.
- Playspeed: controls the playback speed of the clip (movies only). Range is from paused to 4x normal speed.
- In/Out Frame: sets the in and out frame points within the full length of the clip. Range is from the beginning to the end of the clip, counted in frames. Both frame numbers and actual time values are shown beneath the sliders.
- Volume: controls the output level of audio when the clip is loaded into the program bus. Clips playing in the preview bus do not play audio. Range is from 0 to 200%.
- Set In/Out Frame: these buttons can be used to snap the in/out frame to the current preview bus playhead position, either during playback or when paused.

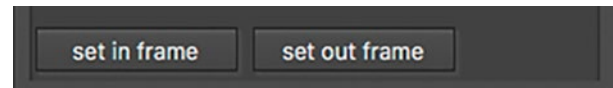
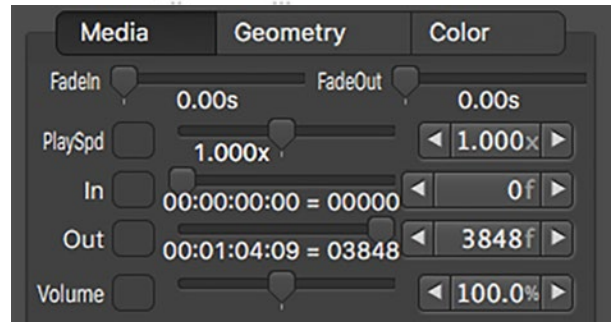

+ Geometry

- X/Y Position: sets the X (left/right) and Y (up/down) position of the clip. By default, clips are centered.
- Scale: adjusts the size of the clip. By default clips are scaled to best fit the show output. Range is from 0x to 1000x normal size.
- Aspect: adjusts the aspect ratio of the clip. By default all clips are shown at a 1:1 aspect. Range is from 1:4 to 4:1.
- Crop: allows cropping shutters to be added separately on each of the four sides of the clip.

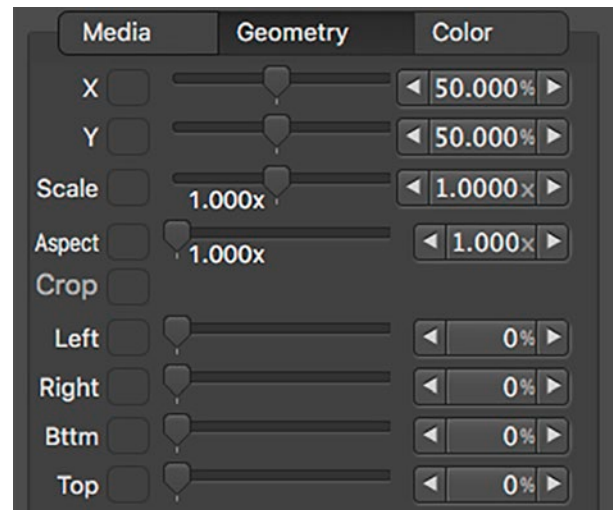

+ Color

- Red/Green/Blue: adjusts the RGB color of the clip. Default value is 50%; color can be added or subtracted. Range is 0% (subtractive) to 100% (additive).
- Brightness: adjusts the brightness of the clip. Default value is 50%; the clip can be made brighter or darker. Range is 0% (darkest) to 100% (brightest).
- Contrast: adjusts the contrast of the clip. Default value is 50%; contrast can be added or subtracted. Range is 0% (least contrast) to 100% (highest contrast).
- Hue: adjusts the overall color of the clip. Default value is 50%.
- Saturation: adjusts color saturation of the clip. Default value is 50%. Range is 0% (grayscale) to 100% (over-saturated).

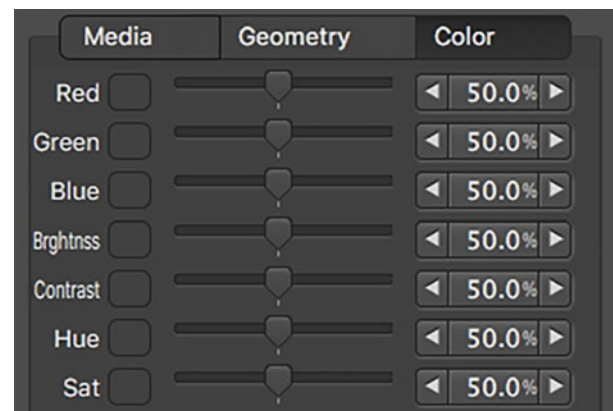

CAUTION!! Editing the properties of a clip at the moment that another clip gets loaded into either bus may cause the edits to be incomplete or discarded. If a clip is about to end, avoid editing its properties!

Each of the three property group tabs and each property within the groups will display a button with a white indicator dot to show that the property or one or more properties within the group have been changed from their default value. To reset one property to its default value, click on the button to the right of the property's name. To reset all properties in a group, right-click on the corresponding tab and select Clear All in '??' group - where ?? is the name of the group.

Below the clip properties are various playback controls for the preview bus. This area includes buttons to start and stop playback (in the preview bus only) and also controls for setting in and out frame points and scrubbing the playhead.

Note: The playback controls apply for all clips: movies, still images, standalone audio files, and text files.

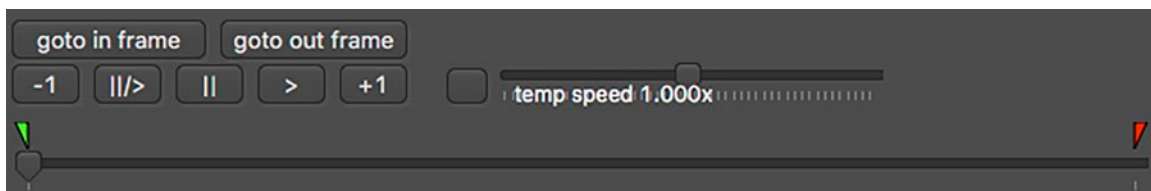

+ Playback Controls

- Goto In/Out Frame: these buttons snap the preview bus playhead to the in/out frame points.
- -1/+1: when the clip is paused, these buttons step the clip backwards or forwards in one-frame increments.
- Pause/Play: acts as a toggle, pausing playback if the clip is playing, and playing if the clip is paused.
- Pause: pauses playback if the clip is playing.
- Play: starts playback if the clip is paused.

Note: Clips do not automatically play when loaded into the preview bus. The play button must be pressed. Also, clips in the preview bus do not follow their assigned end-of-clip actions - they don't loop, freeze, or link - they just play from in frame to out frame then stop. To replay the clip, the play button must be pressed again.

+ Temp Speed

- This slider allows the playback speed of a clip to be adjusted without the speed being saved and applied when the clip is loaded into the program bus. Changes to the temp speed can be canceled by pressing the reset button to the left of the slider. The temp speed will be automatically reset if a new clip is loaded into the preview bus.

+ Scrub Bar

- The scrub bar can be used to view and/or scrub the preview bus playhead position. Additionally, the green and red markers above the scrub bar can be used to view and/or adjust the in and out frame points.

Note: In the preview bus, moving the playhead or the in/out frame markers on the scrub bar will cause the clip to jump to that position and pause. Playback will not restart unless either the pause/play or play button is pressed. However, in the program bus, the in/out frame markers on the scrub bar *can* be moved while the clip is playing, without the playhead jumping to that position and pausing.

The right side of the preview bus area holds the live preview for the bus. Changes to the clip's properties and playback can be viewed here before the clip is loaded into the program bus.

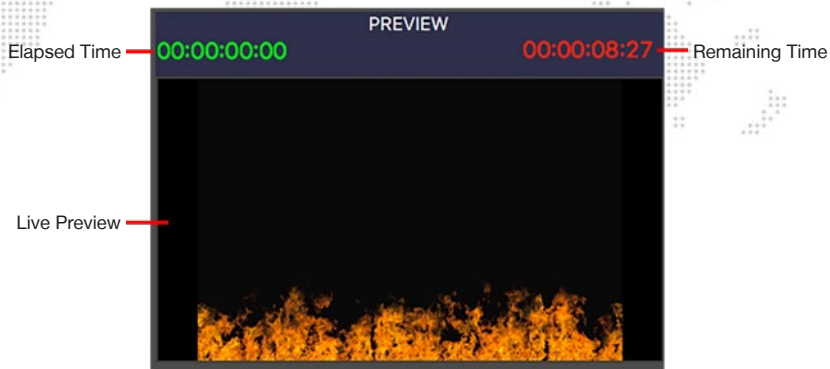

The preview bus will always be formatted (both image size and aspect ratio) to match Mbox Player's show output. Therefore the live preview is an accurate representation of what the clip will look like when it is loaded into the program bus and viewed on the show output.

Above the live preview are two counters, with the green text showing the elapsed time from the in frame and the red text showing the remaining time until the out frame.

Program Bus

The program bus area on the bottom-right of the main window is used to view, play back, and adjust the properties of the clip loaded into the program bus.

IMPORTANT! Whenever a clip is loaded into the program bus it will also be visible on the computer's show output.

Like the preview bus, the program bus has three major components: clip properties, playback controls, and the actual preview. Refer to the descriptions on the previous pages for detailed information on these items.

CAUTION!! Modifying any clip properties while the clip is loaded into the program bus will immediately change those properties and the changes will be visible on the computer's show output.

The controls in the program bus area have three notable differences from those in the preview bus area:

- + An Audio Level indicator is located directly below the program bus live preview. This level indicator shows as a colored line when a movie with embedded audio is playing. The length of the line varies based on the audio level in the clip. Changes to the volume property of the clip will be reflected in the audio level indicator.
- + Below the level indicator is the Mute button. Pressing the Mute button will completely mute all audio from any clip in the program bus.

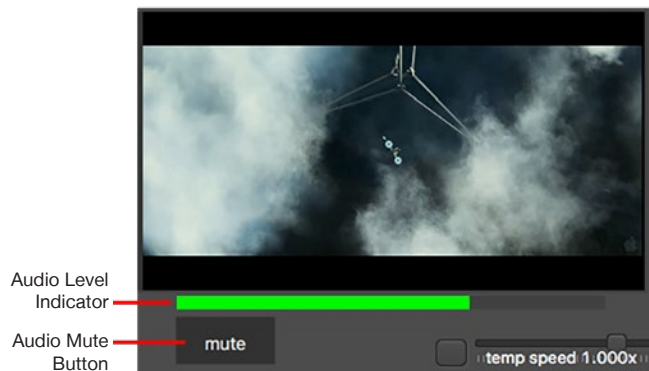

CAUTION! When the Mute button is pressed, the muting is not cleared when a new clip is loaded into the program bus. All audio output from subsequent clips in the program bus will be muted until the button is pressed again to unmute the audio.

- + On the red counter above the program bus live preview image, the digits representing seconds will be underlined and will flash between red and white during the last 10 seconds of the clip. This is intended as an indication that the clip is about to end so that manual action can be taken if necessary.

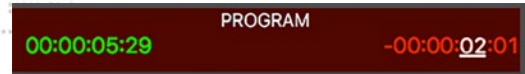

Action/Override Area

The Action/Override area, located above and between the preview and program bus areas, is used to load clips into either the preview or program buses, and to manually override their playback position or their fade in/out timing and end-of-clip actions that were pre-assigned in the clip list.

+ Take and Kill Buttons

- The Take button (or [return] key) is used to manually load a clip from the preview bus into the program bus. Pressing the Take button will load the clip into the program bus, overriding any existing end-of-clip actions for the clip. When the Take button is pressed, there may be a crossfade, cut, or delay based on the position of the sliders above the button.
- The Kill button (or [esc] key) is used to manually clear the program bus, blacking out the computer's show output. When the Kill button is pressed, the clip in the program bus will either cut to black or fade out based on the position of the slider above the button. The clip in the preview bus will not be loaded into the program bus.

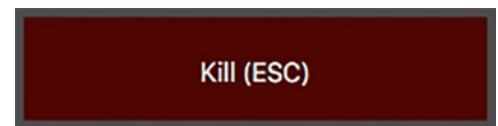
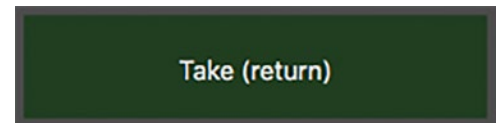

+ Take and Kill Sliders

- Take Fade Out: used when the Take button is pressed to apply a variable fade-to-black time to the clip in the program bus before it is replaced by the clip in the preview bus. Setting the slider to a value of 0 seconds causes a cut.

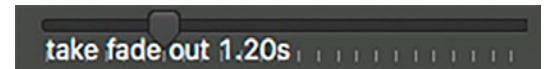

Note: The Take Fade Out slider is hidden and its assigned fade-to-black time ignored when the Take Crossfade/Cut/Delay slider is set to a crossfade.

- Take Crossfade/Cut/Delay: used to assign a crossfade, cut, or delay action for the transition between the clip in the program bus and the clip that will replace it when the main Take button or any immediate take button is pressed. The default value of 0 seconds represents a cut, and allows the Take Fade Out slider to be used. Moving the slider to the left or right causes either a crossfade (left) or a delay (right) to be applied for the transition between clips.
- Kill Fade Out: used to apply a variable fade-to-black time to the clip in the program bus that is used when the Kill button is pressed. Setting the slider to a value of 0 seconds causes a cut.

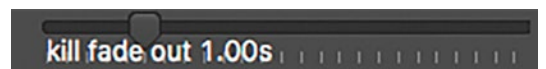

+ Goto Buttons

- The four Goto buttons can be used to immediately jump the clip in the program bus to a predetermined point in the clip - either the In Frame or 10, 20, or 30 seconds from the end of the clip.

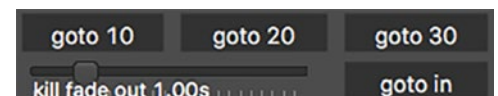

+ End-of-Clip Overrides

- Loop Crossfade/Cut/Delay: when the Loop button is depressed, the slider controls the loop timing - to the left for a crossfade from out frame to in frame, in the center for a 0 second cut, or to the right for a delay in black.

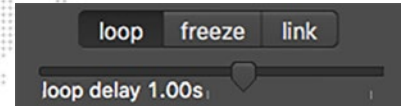
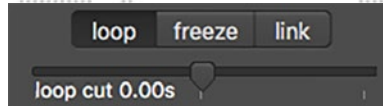
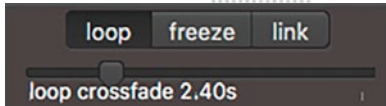

- Freeze: when the Freeze button is depressed, the clip will always freeze on the out frame. The slider has no effect when the freeze option is selected, therefore it is hidden.

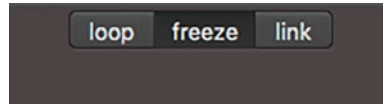

- Link Crossfade/Cut/Delay: when the Link button is depressed, the slider controls how the program bus will transition from the current clip to the clip that is loaded into the preview bus - to the left for a crossfade, in the center for a cut, or to the right for a delay.

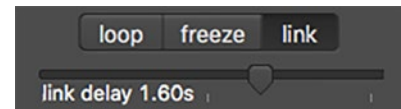
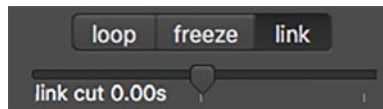
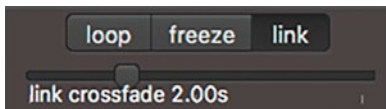

Note: The end-of-clip override controls are intended to be used to override the pre-assigned actions from the clip list, and are only visible when a clip is loaded into the program bus. Whenever a clip is loaded in the program bus, the buttons and the slider will show the end-of-clip action that was assigned to the clip in the clip list.

Preferences Window

The preferences window can be opened by pressing [⌘ ,] on the keyboard or clicking on the File menu in the menu bar, and then selecting the Show Preferences option. The preferences window has three tabs: General, Sync, and OSC.



General preferences:

- + **Rendering Frame Division:** Sets the overall rendering rate for the Mbox Player application to either the nominal refresh for the show output (“x1”) or to half that frequency (“÷2”). Reducing the rendering rate can be beneficial for increasing performance (eliminating dropped frames) on slower computers. The default is x1.
- + **Audio Offset (S):** Sets the offset between the video and audio playheads. Positive values advance the audio, negative values delay the audio. The offset is entered in seconds and can have a range of -2.000 S to 2.000 S. The default is 0.000 S.
- + **Background Color (R,G,B):** Sets the background “clear” color for Mbox Player. It can be useful to change the background color to a specific color to allow Mbox Player’s output to be routed into an external compositing device which could then render that specific color as transparent - thereby allowing Mbox Player’s output to be used as an overlay on top of other content. The background color defaults to black - (0.0, 0.0, 0.0).
- + **End-of-Clip Warn Time:** Set the remaining time value when Player starts to warn the operator that a clip in the program bus is about to end. The default is 10 seconds.
- + **200% Clip Volume:** Enables/disables 200% output volume level. Disable this preference to allow older Player showfiles to be used without all audio output being 2x the originally intended level. The default is enabled.

Sync preferences:

- + **Sync Interface:** Selects the network interface that Mbox Player will use when listening for commands from the Mbox Player Sync application. The pop-up will show all currently active interfaces on the computer. If an interface was previously selected for use, but is now inactive, its name will be shown in gray rather than black.
- + **Sync Group:** Selects the sync group that Mbox Player will be part of when listening for commands from the Mbox Player Sync application. Sync Groups A through H are available
- + **Sync Delay (mS):** Sets the delay time that Mbox Player will apply to any commands received from the Mbox Player Sync application. The delay time is entered in milliseconds and can have a range of 0 mS to 10,000 mS. The default is 0.0 mS.

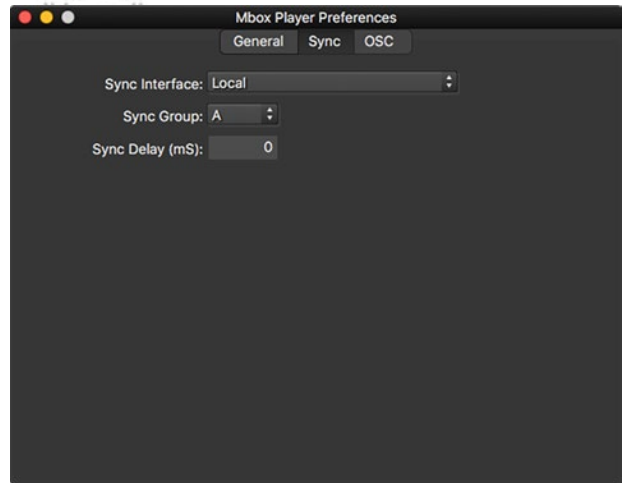

OSC preferences:

- + **OSC Enabled:** Turns on/off OSC functionality. Causes network to be rescanned for OSC devices if toggled.
- + **Input Port:** Sets the port number that Mbox Player will use to receive OSC commands from an external source. The default is port 9000.
- + **Output Port:** Sets the port number that Player will use to send OSC feedback to external sources. The default is port 8000.
- + **Feedback Loop Detection:** Allows Player to provide warnings about feedback loops.

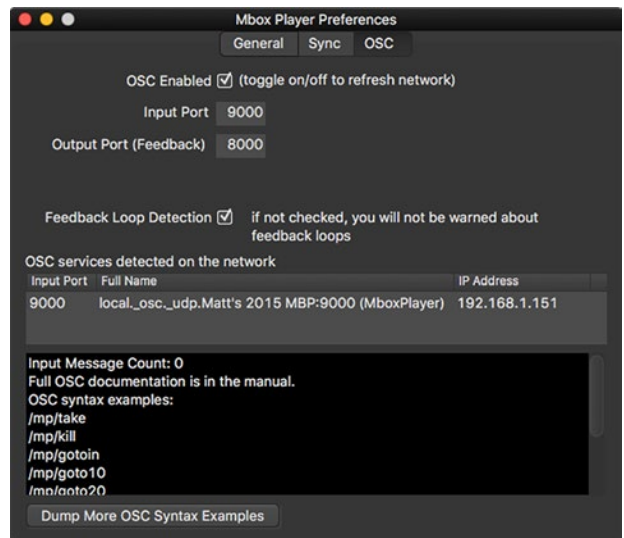

The OSC tab also shows examples of typical OSC commands that Mbox Player can receive. Pressing the button labeled “Dump More OSC Syntax Examples” will open a separate window that shows all possible OSC input commands.

Note: Refer to [“Mbox Player Sync Application”](#) on page 62 for more information on the remote control of Mbox Player.

CONNECTED DISPLAY AND FULLSCREEN MODE INTERACTIONS

Overview

As noted in [“Show Output Window”](#) on page 8, Mbox Player requires a second display to be connected to the computer for there to be a proper fullscreen show output. Without the second display, Player will only ever display the show output as a window. If a second display is connected to the computer, when the Mbox Player application is launched, Player will automatically use that second display as the show output.

IMPORTANT! The second display must be connected prior to launching the Mbox Player application. If the application is launched with only one display connected to the computer, and a second display then connected, the application must be quit and relaunched to allow it to go into fullscreen mode on the second display.

Without special hardware or software, a typical computer can only output video resolutions and frequencies that are supported by the connected display equipment. Display devices communicate their possible input formats via EDID (Extended Display Identification Data). The EDID data provides information on preferred formats and available alternate formats.

When connecting the video outputs of the Mbox Player computer to a display device, first confirm that the display device appears in the computer’s System Preferences > Displays pref pane. On most Macs, the computer will automatically read the EDID of displays when they are first connected. It is possible to force the computer to reread EDID from connected displays by pressing the “Detect Devices” button on the Displays pref pane.

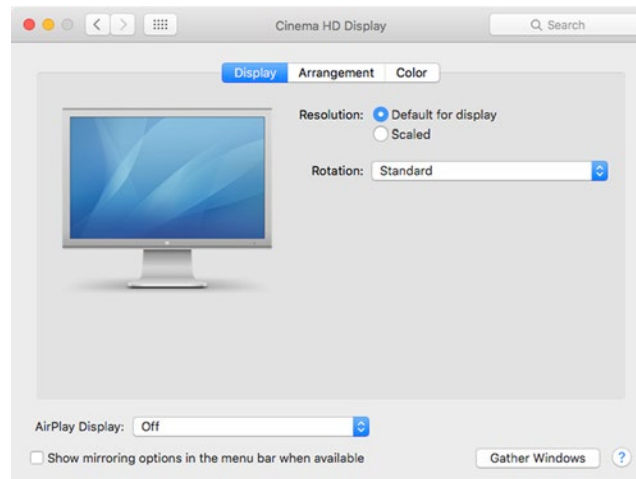

Note: In newer versions of the Mac operating system, the Detect Displays button is not visible unless the [option] key is pressed.

By default, the pref pane will select the preferred format for the display (i.e. “Default for display”). Clicking on the “Scaled” radio button will allow the selection of additional formats. Some formats will allow a selection of alternate refresh frequencies, but this will depend on the display device.

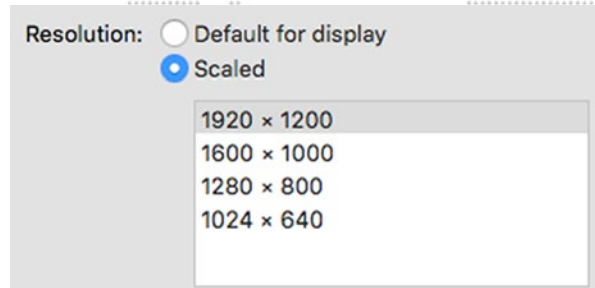

Clicking on “Scaled”

Even after clicking on the “Scaled” radio button, all of the possible formats for the display may not be shown. Holding down the [option] key and clicking on the radio button may reveal more formats.

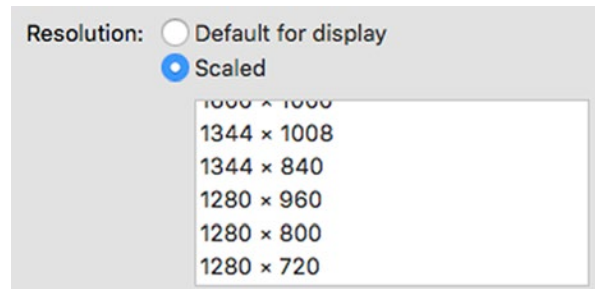

Option-clicking on “Scaled”

Assuming the desired format (resolution and frequency) is available for selection on the Displays pref pane, the next step is to actually select that format. If a format with the desired resolution and/or frequency are not available, then it may be that the connected display device does not support the desired format. In which case, the display device could be replaced with one that does support the desired format or it may be necessary to use a device between the computer and display device to “spoof” EDID. Spoofing EDID can allow the computer to output formats that may not be supported by the display device. In some cases this can be critical to getting the desired output format, but in other cases it may result in a lack of picture on the display device.

Note: Devices like the Gefen DVI Detective or Brompton DVI Parrot may be used to spoof EDID.

The Mbox Player application reads the current resolution and frequency of the computer’s second display (as provided by the OS) when the application is first launched. When Player goes into Fullscreen mode it will **only** use the resolution and frequency that the display is currently set to by the OS. **The resolution and frequency of the second display should be pre-set in the System Preferences > Displays preference pane before launching the application.**

Mbox Player does not attempt to change format on the second display when going into Fullscreen mode. However, if the second display’s format is changed on the Displays pref pane while Mbox Player is running, the fullscreen show output on the second display will immediately be reconfigured to use that new format.

WARNING!! While possible, it is not a good idea to change the format for the computer’s second display while the Mbox Player application is in fullscreen mode. This is primarily because it can cause an undesirable disturbance in the output.

ENHANCING MBOX PLAYER PERFORMANCE

Recommended Hardware Practices

Use the following recommendations for hardware:

- + Mbox Player is compiled for Intel processor computers only and does not run natively on Apple Silicon computers. While every attempt has been made to ensure compatibility, avoid using Apple Silicon computers if at all possible.
- + Mbox Player will use as many CPU cores as possible; more CPU cores can provide better performance.
- + CPU speed is also a factor, but based on the speed of most modern Macintosh hardware, CPU speed has less impact than the number of cores.
- + The OS will let Mbox Player use as much RAM as the computer has. More RAM (at least 16GB) is advantageous.
- + Mbox Player puts a heavy load on the computer's GPU, the most powerful GPU is always the best choice.
- + Mbox Player requires fast and constant access to file storage. SSDs and flash-based storage will provide the best results.
- + Modern Mac hardware can connect peripheral devices using Thunderbolt. Computers may have a limited number of Thunderbolt buses available - and therefore a limited amount of bandwidth. Always try to connect Thunderbolt devices to the correct bus to maintain adequate bandwidth.

Recommended OS Setup

Use the following recommended practices to enhance the performance of the Mbox system:

- + Use macOS 10.13.6 High Sierra through 10.15 Catalina if possible. Avoid newer versions of macOS if possible.
- + Disable any screen-savers.
- + Disable File Sharing and Remote Management (any and all sharing, in fact).
- + Turn off automatic software updates.
- + Disable Spotlight on all connected hard-drives by placing them in the Privacy table.
- + Set Energy Saver settings to disable computer and display sleep, and to stop hard-drives from being put to sleep.
- + If using a laptop with two graphics modes, disable automatic switching (use max performance).
- + Disable Time Machine.
- + Disconnect the computer from the internet.
- + Disable Mission Control functions and keyboard shortcuts.
- + Make sure that the "Displays have separate Spaces" pref is not checked.
- + Turn off FileVault and Firewall.
- + Disable the Notification Center entirely or turn on Do Not Disturb for notifications.
- + Turn off automatic data and time setting.
- + Quit all other applications and disable unnecessary background processes!

Mbox Player Setup

- + Set the Rendering Frame Division preference to ÷2 if video frames are dropped and playback looks jerky.



4.

OPERATION

This chapter provides operating instructions for the Mbox Player software

- + **SHOWFILE MANAGEMENT**
- + **CLIP MANAGEMENT**
- + **END-OF-CLIP ACTIONS**
- + **PREVIEW BUS - ADJUSTING CLIP PROPERTIES**
- + **PROGRAM BUS - SHOW OUTPUT**
- + **MANUAL OVERRIDES**
- + **REMOTE CONTROL VIA OSC**
- + **TIPS AND TRICKS**
- + **AUDIO OUTPUT**



SHOWFILE MANAGEMENT

Overview

When first installed and launched, Mbox Player will start with an empty showfile. Content can be added to the clip list, and their various properties and end-of-clip actions can be edited. If the application is closed with no other steps taken, the changes to the show data will be automatically saved in a temporary storage location. Thereafter, the Player application can be relaunched and this previous data will be restored. This feature means that showfile data will not be lost even if it is not intentionally saved.

In addition to the automatic saving of show data, the data can be saved as a file on the computer or any drive attached to the computer. This allows the show data to be backed up or moved from one computer to another. Show data is saved and opened using the application's File menu or equivalent keyboard shortcuts.

CAUTION! New features added to Mbox Player v1.3 mean that showfiles created with Player v1.3 are not compatible with older versions of Mbox Player! However, an old showfile can be opened and resaved using Player v1.3

Save/Open/New Showfile

To save show data as an Mbox Player showfile:

- Step 1. Add content to the clip list and edit the clip properties as required.
- Step 2. Click on the File menu and select Save Show, or press [⌘S].
- Step 3. If an existing showfile was open, the show data will be saved to that file.
 - a. If no showfile was open (i.e. a new show was started) a file save dialog will open, allowing the showfile name and location to be selected. Click on the Save button to save the showfile.

To save show data using a new name or location (save-as):

- Step 1. Click on the File menu and select Save Show As... or press [⌘⇧S].
- Step 2. A file save dialog will open, allowing the showfile name and location to be selected.
- Step 3. Click on the Save button to save the showfile.

To open a showfile:

- Step 1. Click on the File menu and select Open Show... or press [⌘O].
- Step 2. A file open dialog will open, allowing the showfile name and location to be selected.
- Step 3. Click on the Open button to open the showfile.

To start a new showfile:

- Step 1. Click on the File menu and select New Show.
- Step 2. If the existing show has unsaved data, an alert panel will open. Buttons on the alert panel allow either the new show action to be canceled (and the existing show saved normally before continuing), or the changes to the existing show can be discarded and a new showfile created.

Note: Mbox Player showfiles use the proprietary .mboxplayer file extension.

CLIP MANAGEMENT

Overview

Mbox Player relies on the content that is added to the clip list for playback. Creating a show requires content to be added, and subsequent management of the show may require these clips to be deleted, edited, moved, or renamed.

As noted in [“Content Management”](#) on page 23, it is always best to keep all content in one location. Keeping all content in one place simplifies clip management, when the content is copied onto the computer, when it is added to the clip list in Mbox Player, and also if the showfile and content is moved to another computer. Also, as noted in [“Clip Formatting Guidelines”](#) on page 22, there are restrictions on the type of movie, still image, and standalone audio files that Mbox Player can use. Make sure to format all content files correctly before adding them to the clip list.

Adding Content to the Computer

Before being used with Mbox Player, content must first be copied to the computer’s hard-drive or a connected drive. Refer to [“Adding Content”](#) on page 24 for information on supported file extensions.

Adding Content to the Clip List

Step 1. Click on the “+” button at the top-left of the clip list or press [⌘ N] on the keyboard to open the file selection dialog for adding content to the clip list.

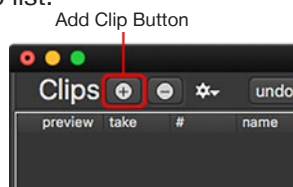

Step 2. In the file dialog that opens, select one or more pieces of content (movie, still image, text, or standalone audio) to add to the clip list, then press the Open button to add it/them.

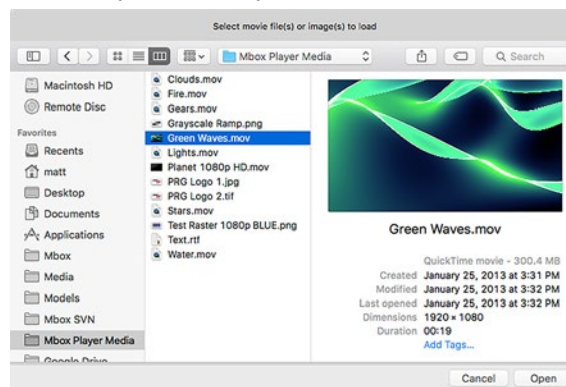

- a. If a clip was selected (has a blue highlight) in the clip list prior to adding new clips, the new clip(s) will be added immediately after the selected clip.
- b. If no clip was selected in the clip list, the new clip(s) will be added at the bottom of the clip list.

Note: Beginning with Mbox Player v1.1 content can be dragged from a Finder window and dropped onto the clip list, either to add new content or to replace existing content.

Step 3. Alternately, content can be dragged onto the clip list. In such cases, a thin blue divider line indicates where in the clip list the dragged content will be placed when dropped, or if replacing a clip, the entire row will be highlighted in blue.

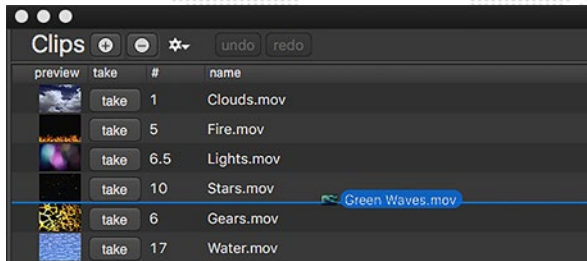

Add Clip

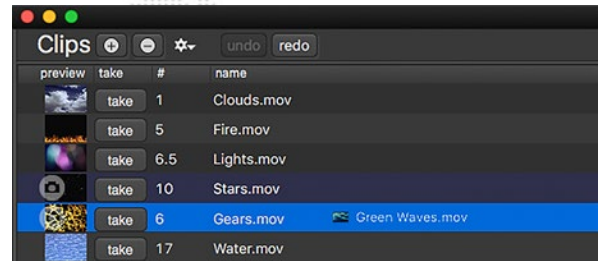

Replace Clip

Step 4. Continue adding clips to the list as required.

Note: If multiple content files are selected in the add clip dialog, then they will all be added to the clip list sequentially in the order they were displayed in the file selection dialog or Finder window - typically alphabetical order.

Adding Sidecar Audio to Clips in the Clip List

In addition to the ability to have standalone audio files in the clip list, Mbox Player also allows “sidecar” audio files to be added to an existing clip in the clip list. (Refer to [“Audio”](#) on page 69 for more information about sidecar audio files) Sidecar audio files can be added to any existing clip in the clip list as long as that clip is not a standalone audio clip.

To add a sidecar audio file to an existing clip, right-click on the existing clip in the clip list, and select the “🎵 Set Sidecar Audio File for Clip” option from the contextual menu. And then on the file selection dialog that appears, select the audio file.

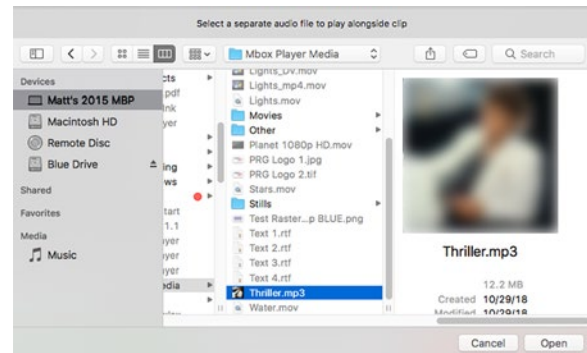
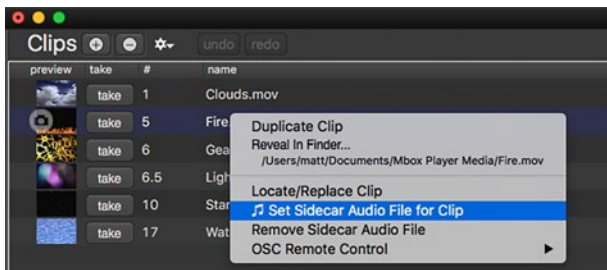

Clips with sidecar audio are displayed in a slightly different style in the clip list. Whereas movie, still image, text, and standalone audio files are all shown with a single line, clips with sidecar audio are shown using two lines, with the original clip on the top line and the audio shown on the line below and having a musical note symbol 🎵.

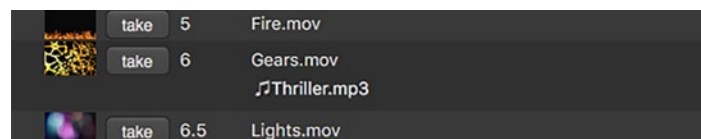

Note: Beginning in Mbox Player v1.3, Player makes “auto-sidecar” audio files for movies that have embedded audio using LPCM (uncompressed) audio encoding. Auto-sidecar files use the .caf file extension, are placed in the same folder as the associated movie, and do not need to be manually added to the clip as a sidecar audio file.



Removing Clips from the Clip List

- Step 1. In the clip list, select the clip to be deleted.
- Step 2. Use one of the following methods:
 - a. On the computer keyboard, press [⇧⌘] to delete the clip immediately.
 - b. Click on the “-” button at the top-left of the clip list or press [⌘]. Both of these methods will bring up an alert window that allows the clip to be deleted. This alert window also has a checkbox that can be checked to suppress the alert in future, thereby allowing the “-” button or [⌘] to immediately delete the selected clip in the future.
- Step 3. If the clip has sidecar audio, the audio will be deleted as well.

Note: The clip that is currently loaded into the program bus cannot be deleted, even if it is the selected clip.

Copying and Pasting Clips in the Clip List

Once they have been added to the clip list, clips can be copied and pasted. Copying clips allows the same clip to be used multiple times in the show without having to add the same clip more than once. Furthermore, copies of a clip will keep the same properties as the original, including any sidecar audio.

- Step 1. In the clip list, select the clip(s) to be copied. Use shift-click to select a range, or command-click to make multiple non-consecutive selections.
- Step 2. Use one of the following methods to copy the clip(s):
 - a. On the computer keyboard, press [⌘C].
 - b. Go to the Edit menu on the application’s menubar (at the top of the primary display) and select Copy.
- Step 3. Using the mouse, select the clip prior to where the copies should be pasted. Copies are always placed after the selected clip.
- Step 4. Use one of the following methods to paste the clip(s):
 - a. On the computer keyboard, press [⌘V].
 - b. Go to the Edit menu on the application’s menubar (at the top of the primary display) and select Paste.

Replacing Content in the Clip List

When creating a show, it may be necessary to replace a clip in the clip list with some other piece of content. Either because the source file has been edited or because a different file should be used. It is quick and easy to replace existing clips.

To replace a single still image, movie, or standalone audio clip:

- Step 1. Select a clip and press [⌘L].
 - a. Alternately, right-click on the clip to be replaced. In the resulting contextual menu, select the option to Locate/Replace Clip.
- Step 2. In the file dialog that opens, select the piece of content that will replace the existing clip. Then click the Open button.

- Step 3. Alternately, individual clips can also be dragged from a Finder window onto the clip list to replace an existing clip, which is indicated by highlighting the entire clip row in blue. After dropping the new file, a confirmation is required.

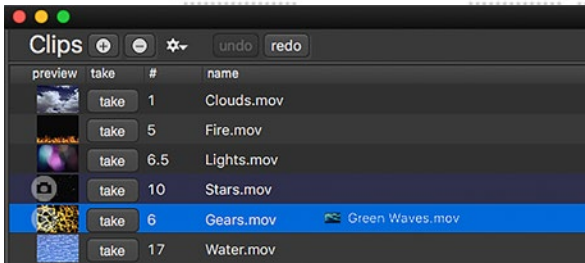

Replace Clip

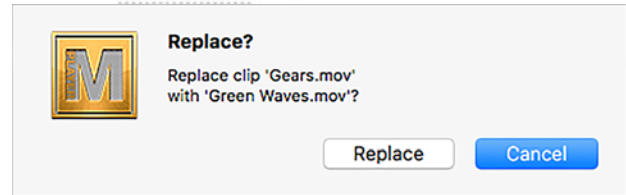

Confirmation

To replace multiple still image, movie, or standalone audio clips:

- Step 1. Select multiple clips in the clip list using either shift-click for a consecutive range or command-click for non-consecutive selection.
- Step 2. Press [⌘L] or right-click on one of the selected clips. In the resulting contextual menu, select the option to Locate/Replace Clip.
- Step 3. In the file dialog that opens, select one or more clips to replace the existing clip. Then click the Open button.
- Step 4. Depending on number of replacement clips selected in Step 3, further interaction may be required to complete the replacement:
- If only one replacement clip was selected, a separate copy of that one clip will replace each of the clips selected in Step 1. No further interaction is required.
 - If one or more clips having identical names to those selected in Step 1 are selected, then if possible they will automatically be replaced. Further interaction is required (see below) for clips not having identical names or if Player is unable to match the file names.
 - If multiple clips are selected and any file does not have an identical name to one selected in Step 1, or if Player can't make an automatic replacement, a dialog will appear. The dialog allows replacements to be made using either selection order or by attempting to match the file name.

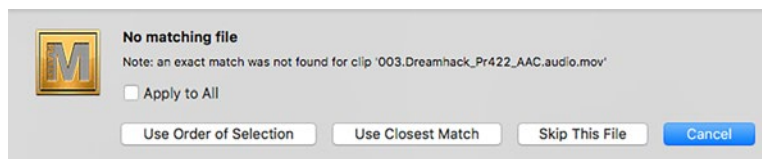

- 1) When using order of selection, clips will be replaced following their order in the clip list by the replacement clips in the order they are shown in the file selection dialog (Step 3).
- 2) When using closest match, Player will make its best guess at matching replacement file names to the original file names. With identical or very similar names this can be effective, but with significant differences this method doesn't produce the best results.
- 3) In the dialog, the replacement of individual clips can be skipped by pressing the Skip button. The skip action or either of the two replacement methods can be applied to all subsequent replacements by checking the Apply to All checkbox before pressing the desired button. If fewer replacement clips are selected than the number of original clips, then after the ordered/matched replacements are made, the remaining clips will be replaced by the last replacement clip.
- d. If more replacement clips are selected than the number of original clips, then after the ordered/matched replacements are made, the extra replacement clips will not be used.

CAUTION! Clips loaded in the program bus can't be replaced immediately. If the clip in the program bus is replaced, the replacement is loaded into the preview bus and can then be loaded into the program bus by pressing the take button.

To replace a sidecar audio file:

- Step 1. Select the clip having the sidecar audio and press [⌘L].
 - a. Alternately, right-click on the row for the clip with sidecar audio. In the resulting contextual menu, select the option to Locate/Replace Clip.
- Step 2. In the file dialog that opens, select an audio file (not a movie or still image file) as the replacement file. Then click the Open button.

Reordering Clips in the Clip List

Clips in the clip list can be reordered using drag and drop. To move a clip in the list, click anywhere in the clip's row, then drag up or down. While dragging, the clip's thumbnail will be ghosted above the clip list and a blue line will show where the clip will be dropped when the mouse button is released. Only one clip can be dragged at a time.

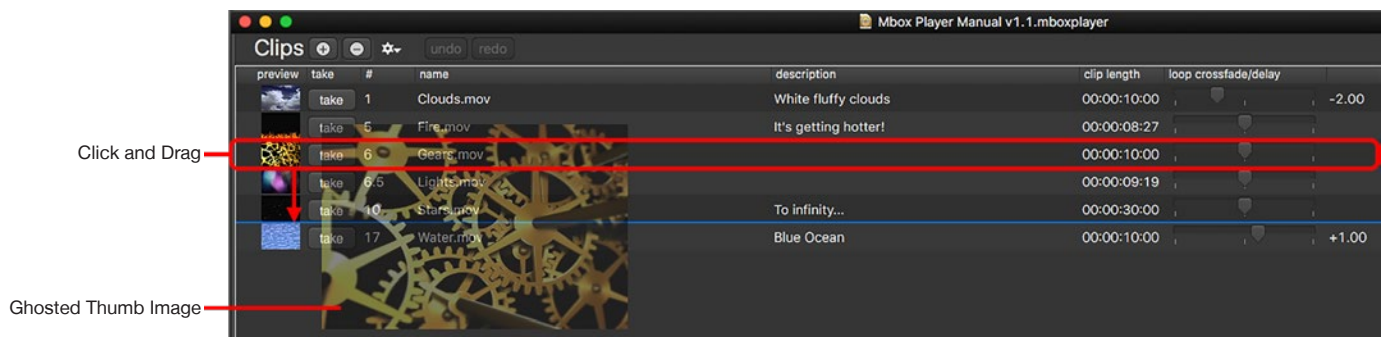

Missing Content in the Clip List

The clips in Mbox Player’s clip list are linked to files that can be stored on any drive that is connected to the computer. These files are identified by their location and name (i.e. their “path”). If the files that are being used by Mbox Player are moved or renamed, or if the drive they are on is disconnected from the computer, then those clips will not play. Missing clips are shown with an orange highlight and a yellow outline in the clip list. Missing clips will also show “File Missing” as an overlay in the column where the clip’s preview thumb is normally displayed.

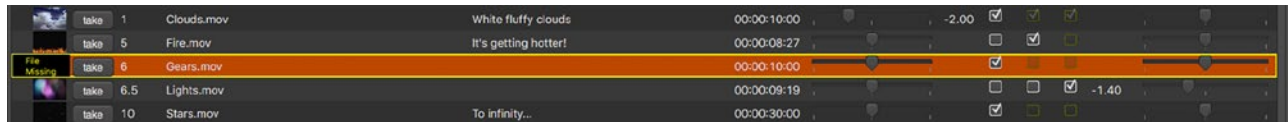

If a missing clip is right-clicked upon, the resulting contextual menu will show a portion of the missing file’s path in red under the “Reveal In Finder...” label. The portion of the path colored red indicates the missing item, be it just the file itself, or the file and one or more of its enclosing folders.

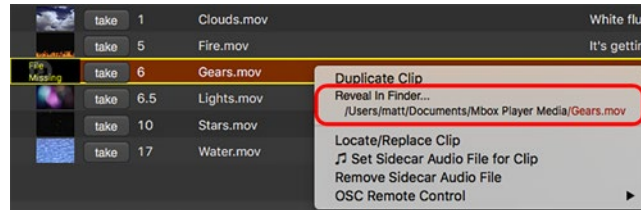

Note: If a still image or movie clip has sidecar audio, either the base clip or the audio (or both) may be missing. Right-clicking on the clip and checking which path elements are colored red will help determine whether one or the other file, or both files is missing.

To Relocate missing clips:

- Step 1. Select the clips that have the orange highlight. Alternately, right-click on them.
- Step 2. Follow the steps used to replace content. Refer to [“Replacing Content in the Clip List”](#) on page 41.

END-OF-CLIP ACTIONS

Overview

The primary purpose of the Mbox Player application is the playback of multiple clips, one after the other. As part of this process, one of the most important features of Mbox Player is the ability to configure what happens when a clip reached the end-of-clip state - does it freeze, does it loop, or does it transition to the next clip automatically?

When first added to the clip list, all movie and standalone audio clips are given their full duration, which can then be adjusted using the in/out frame properties for the clip. Still images and text files are given a default duration of 36 minutes, 24 seconds, and 14 frames, based on 65535 steps of adjustment and 30 fps. Refer to [“Audio File Playback and Output”](#) on page 58 for additional information that can affect sidecar audio file duration.

Every clip in the clip list has an identical set of controls that are used to set the clip’s end-of-clip action. This combination of checkboxes and sliders selects the action, and in the case of loops and transitions, sets the timing for the loop or transition.

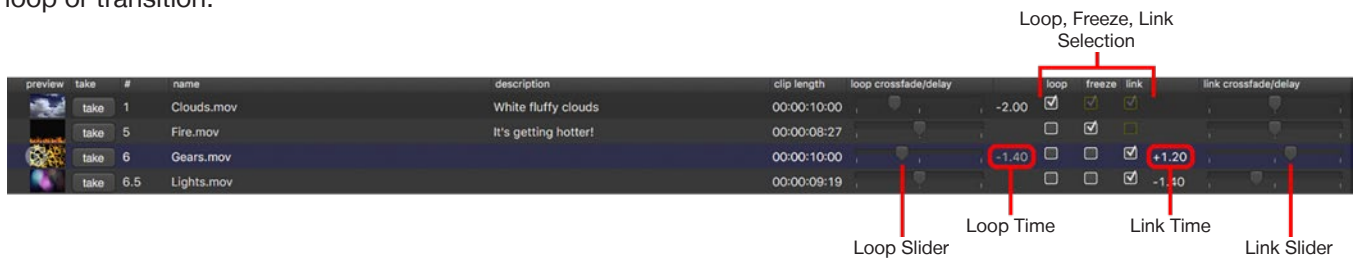

Loop, Freeze, or Link

There are three end-of-clip actions: Loop, Freeze, or Link. Each of these options performs a different action when the clips reaches its end (i.e. its out frame) and the three actions have a priority whereby one action can override another if multiple actions have been selected.

Note: The Loop and Link timing values are shown adjacent to the sliders: loop time is shown to the right of the slider and link time is shown to the left of the slider.

Loop - Selecting the Loop action will cause the clip - if it is a movie - to loop back to its in frame whenever it reaches its out frame. The manner in which the clip loops is determined by the position of the Loop Crossfade/Delay slider, located to the left of the Loop checkbox.

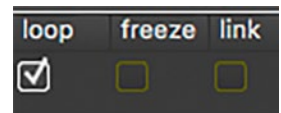

The loop slider defaults to the central position which results in no crossfade or delay at the loop point; the clip will “cut” from the out frame to the in frame. If the slider is moved to the left, the clip will crossfade from the out frame to the in frame, using the time set by the slider (0.10 seconds to 5.0 seconds). If the slider is moved to the right, the clip will delay in black between the out frame to the in frame, using the time set by the slider (0.10 seconds to 5.0 seconds).

Freeze - Selecting the Freeze action will cause the clip - if it is a movie - to freeze on its out frame whenever it reaches the out frame. There is no timing associated with this action.

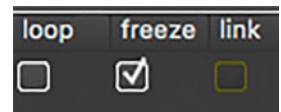

Link - Selecting the Link action will cause two things to happen: when the clip is loaded into the program bus the next clip will automatically be loaded into the preview bus and if the clip is a movie, when it reached its out frame the next clip will be loaded into the program bus automatically. The type and timing of the link transition is determined by the position of the Link Crossfade/Delay slider, located to the right of the Link checkbox.

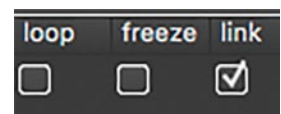

The link slider defaults to the central position which results in no crossfade or delay; the clip will “cut” from the out frame of the first clip to the in frame of the next clip. If the slider is moved to the left, a crossfade happens from the first clip to the next clip, using the time set by the slider (0.10 seconds to 5.0 seconds). If the slider is moved to the right, a delay in black happens between the first clip and the next clip, using the time set by the slider (0.10 seconds to 5.0 seconds).

 **Tip** Loop and link times are shown with a negative “-” or positive “+” sign. The negative sign indicates a crossfade, while the positive sign indicates a delay.

Note: It is perfectly valid to select more than one end-of-clip action, as doing so is often necessary to create the desired result. Refer to [“End-Of-Clip Action Priorities”](#) on page 46 for more information on end-of-clip action priority.

CAUTION! If no end-of-clip action is selected, when the clip reaches its out frame it will fade to black using the current Kill Fade Out Time. The clip will then be reloaded into the preview bus.

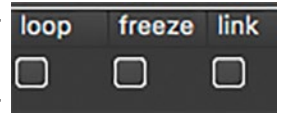

End-Of-Clip Action Priorities

As noted previously, the end-of-clip actions have priorities, such that one action will override the other. Only one end-of-clip action can happen automatically, but in some cases, overridden actions can still be manually triggered. The one active end-of-clip action will always have its checkbox and checkmark highlighted in white, whereas overridden actions will have the checkbox colored a dull orange and checkmark (if present) will be dimmed.

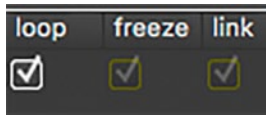

Loop Overrides Freeze & Link

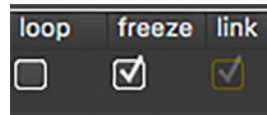

Freeze Overrides Link

Loop Checked - When the Loop action is selected, if either the Freeze or Link actions are selected, they will not be automatically acted upon when the end-of-clip is reached. The Freeze action will always be ignored. However, the overridden Link action *will* cause the next clip to be loaded into the preview bus and clicking on the Take button [return] will cause the next clip to load into the program bus, using the current manual take type and timing specified by the sliders above the Take button.

Freeze Checked - When the Freeze action is selected, if the Link action is selected, it will not be automatically acted upon when the end-of-clip is reached. However, the overridden Link action *will* cause the next clip to be loaded into the preview bus and clicking on the Take button [return] will cause the next clip to load into the program bus, using the current manual take type and timing specified by the sliders above the Take button.

Note: Overridden end-of-clip actions can still be selected or deselected by clicking on their checkbox.

PREVIEW BUS - ADJUSTING CLIP PROPERTIES

Overview

While it would be great if a clip always worked perfectly just as it is rendered, that's not always the case. Sometimes the imagery needs to be shifted or scaled, and the color, brightness, and contrast adjusted. A movie may need to have its in or out frames trimmed or a still image may need have some portion shuttered off. The preview bus is where the bulk of work of customizing the look of clips occurs in Mbox Player.

Before any clip is output from the computer's show output, it is always loaded into the preview bus. While the clip is loaded in the preview bus, its properties can be edited without those changes being seen on the computer's show output. The changes made in the preview bus are immediately visible in the live preview. Furthermore, the live preview shows exactly what the clip will look like when it is eventually loaded into the program bus.

It is this concept - the preview bus being a true preview - that makes Mbox Player convenient and easy to use for playback of sequenced video imagery. Changes can be viewed and saved in advance, and are not output until the desired moment, when the clip is loaded into the program bus. The preview bus acting as a "staging area" for the clip before it is displayed on the show output.

Note: All changes to a clip's properties that are made in the preview bus are automatically saved and recalled the next time the clip is loaded into either the preview or program bus.

Refer to "[Preview Bus](#)" on page 27 for an overview of the clip properties that can be adjusted in the preview bus.

Loading a Clip into the Preview Bus

Any clip can be loaded into the preview bus, either by manual action or automatically. Loading a clip into the preview bus will immediately replace any clip that was previously loaded into the preview bus.

There are several ways that a clip can be loaded into the preview bus:

- + When a clip is selected (clicked on) in the clip list.
- + When a clip is loaded into the program bus, if its link checkbox is checked, the following clip is automatically loaded into the preview bus.
- + If a clip has a clip number in the clip list, the number and period keys on the keyboard can be used to enter a clip number for the Load Clip by Number functionality. As a clip number is entered, it will be shown in white text overlaid on the preview bus' blue header. One second after the last digit is entered, the clip with a matching number will be loaded into the preview bus. [Note: Invalid clip numbers are ignored.]

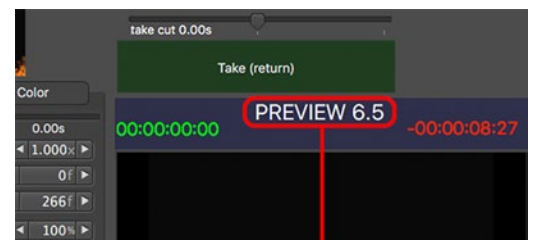

Loading Clip by Number

In the illustrations to the right, "6.5" has been typed on the keyboard, which results in clip 6.5 being loaded into the preview bus (and being selected in the clip list).



To clear the preview bus, press the left arrow [←] key on the keyboard or click on the "Clear Preview" text at the bottom of the clip list.

Clear Preview (← cursor left)

Adjusting Clip Properties

Each property is located on one of three tabs (Media, Geometry, and Color) for organizational purposes. Each property uses very similar controls for adjustment, typically a slider for immediate, fast control, plus a text field with a numerical value and bumper buttons on either side. The only exceptions are the clip's Fade In and Fade Out properties, and the alternate methods for setting a clip's in and out frame values.

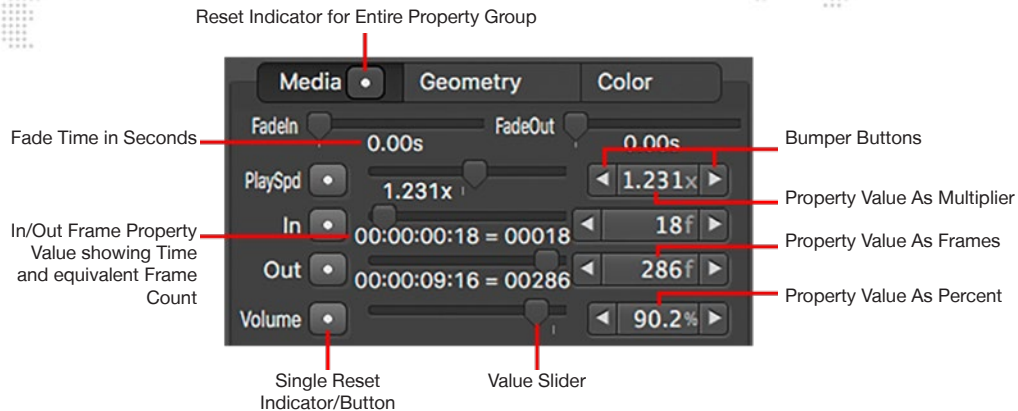

All properties aside from the Fade In and Out properties also have a reset button that allows them to be quickly reset to their default value. In addition to this, the tab that the property is located on will also show a white dot whenever any property on the tab is modified.

Clicking on a button having a white dot will immediately reset the associated property to its default value. Right-clicking on the white dot on a tab will present a contextual menu allowing all properties on the tab aside from Fade In/Out to be reset to their default values.

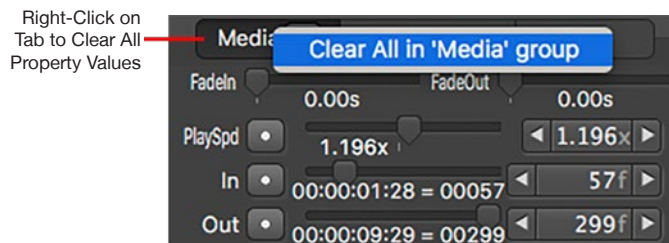

Media Tab

The controls on the Media tab allow for the adjustment of these properties: fade in, fade out, playspeed, in and out frame/duration, and volume.

- + If all the properties on the Media tab are left at their default values, a clip will play in its entirety (from the first frame to the last), at normal playspeed, and with full volume if applicable, and with no fade in or out.
- + Fade In and Fade Out can be used to apply a fade in/out to the start and/or end of a clip when it is loaded in the program bus only.
- + Adjustments to the In and Out Frame properties allow a specific portion of the clip to be selected. These values will be used both when the clip is first played and if it loops. In/out frame values are shown in absolute frame numbers (0 is the first frame) and a time value is shown below each control.

WARNING! If the out frame value is the same as or less than the in frame value, this is considered an error condition and the text under the sliders will be colored yellow. In this case only one frame of the clip will ever play.

- + Playspeed ranges from 0x (paused) to 4x normal speed. The Playspeed property will also affect the duration of a still image or text file.
- + The Volume property masters the volume from 100% of normal volume downwards to 0%.

If the clip is a still image or text file then the in frame control will be disabled and hidden. The out frame control will affect the “dwell” or duration of the image. For example, set the out frame to 299 to make an image’s duration 10 seconds (0 is the first frame, so 0-299 = 300 frames and 300 / 30 fps = 10sec).

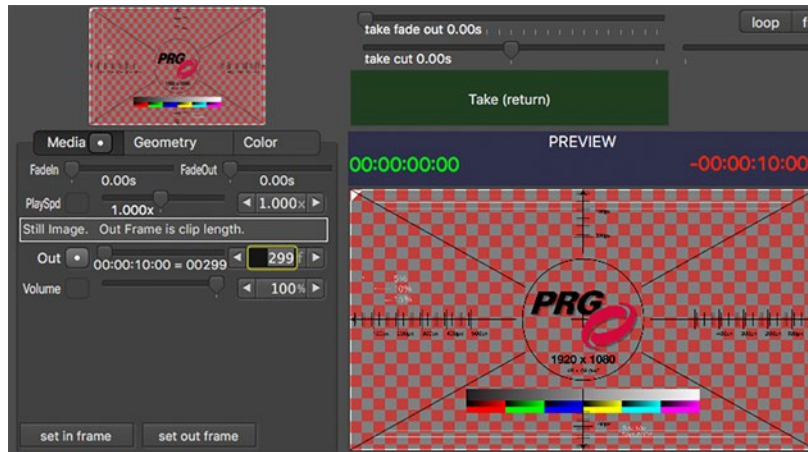

Geometry Tab

The controls on the Geometry tab apply to all types of clips that can be displayed using Mbox Player. By default, every clip is automatically centered in the show output and scaled to “best fit” the show output. Clips are automatically scaled to make it easier to use content of different sizes and have the content quickly fill as much of the show output as possible. “Best fit” in this case means that the clip is scaled up or down so that the entirety of the file fits within the show output, with the proportionally larger dimension exactly fitting the show output.

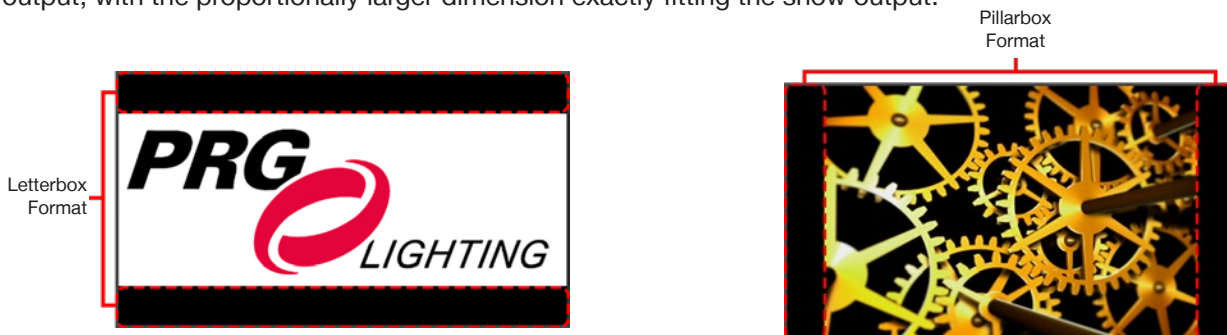

This means that if the aspect ratio of the clip exactly matches the aspect ratio of the show output, then the clip will fit perfectly and there will be no black area outside the clip’s edges unless the scale is reduced. If the clip has a wider aspect ratio than the show output, then the clip will be displayed in a letterbox format. And if the clip has a taller aspect ratio than the show output, then the clip will be displayed in a pillarbox format. The scale property allows the entire clip to be scaled up or down as desired, while still maintaining the native aspect ratio of the clip. The Aspect property allows the clip’s aspect ratio to be adjusted - this is accomplished by adjusting the clip’s width. Therefore to make a clip with a wider aspect ratio perfectly fit the show output, the clip should be scaled up so the top and bottom of the clip fit the show output, and then the aspect reduced so the left and right also fit.

Note: Adjusting the Aspect property can make content look stretched or squished and should be used with care.

The Crop properties work simply, allowing for orthogonal shuttering of the edges of the clip. Adding a crop progressively blacks out the corresponding edge of the clip. The shutters can be used to literally shutter off portions of a projected show output, or to hide portions of the content.

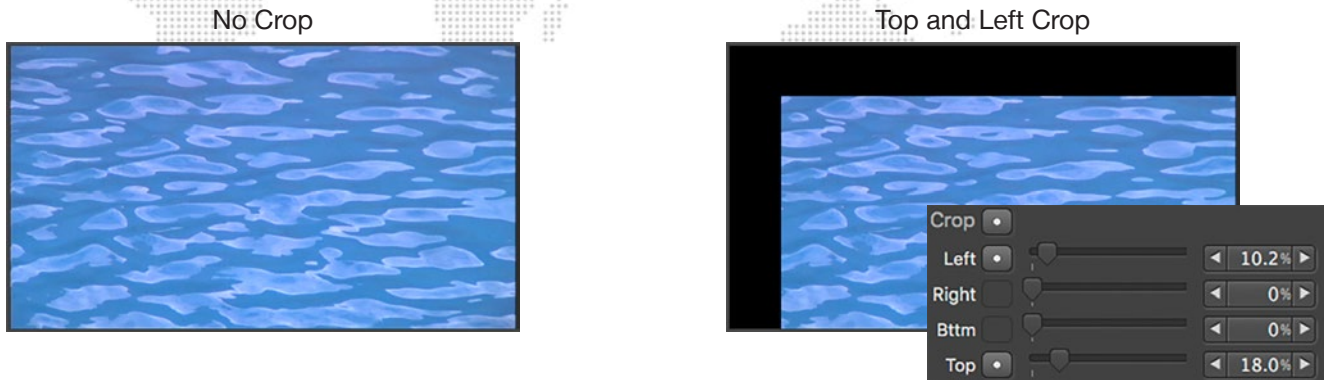

Color Tab

Clips added to Mbox Player will be displayed using their native color. It is possible to adjust individual RGB levels, hue, saturation, brightness, and contrast using the properties on the Color tab.

Tip When using text files, the text in the file will typically have a black color when created. This means that by default, text files won't show up on the show output - since everything is black. To make the text appear, adjust the red, green, and blue or brightness properties.

The Red, Green, and Blue properties allow the amount of each color in the clip to be decreased or increased depending on the position of the slider. A default value of 50% means no change, <50% is decreasing (subtracting) color, and >50% is increasing (adding) color.

The Saturation, Brightness, and Contrast properties work in a similar manner, allowing each to be decreased or increased as desired. The Hue property allows all color in the clip to be affected using the standard hue circle.

CAUTION! The color profile settings on the computer can affect the accuracy of color rendering on the show output. The color profile cannot be adjusted in Mbox Player, but must be adjusted on the System Preferences > Displays pref pane instead.

Playback Controls

While editing the properties of clips in the preview bus it is often necessary to play movie content to view the result of the property changes over the entire movie. The playback controls at the bottom of the preview bus area allow a movie to be played, paused, scrubbed, and stepped.

With the exception of the in frame and out frame markers, the controls in the playback area have no impact on how a movie will play when it is subsequently loaded into the program bus. They are merely used to temporarily control playback while the clip is loaded into the preview bus.

The Goto In Frame and Goto Out Frame buttons will immediately jump a movie to the current in/out frame as set by the sliders on the Media tab. If the movie is playing when either button is pressed, it will pause. These buttons are intended to be used to quickly jump to in or out point to check its position and modify it if necessary.

There are five playback buttons located below the goto buttons: -1, Pause/Play, Pause, Play, and +1. If the movie is playing, pressing any of these buttons (except for the Play button) will cause playback to pause. The -1 and +1 buttons are intended to bump the movie backwards or forwards by exactly one frame and are typically used for finding an exact

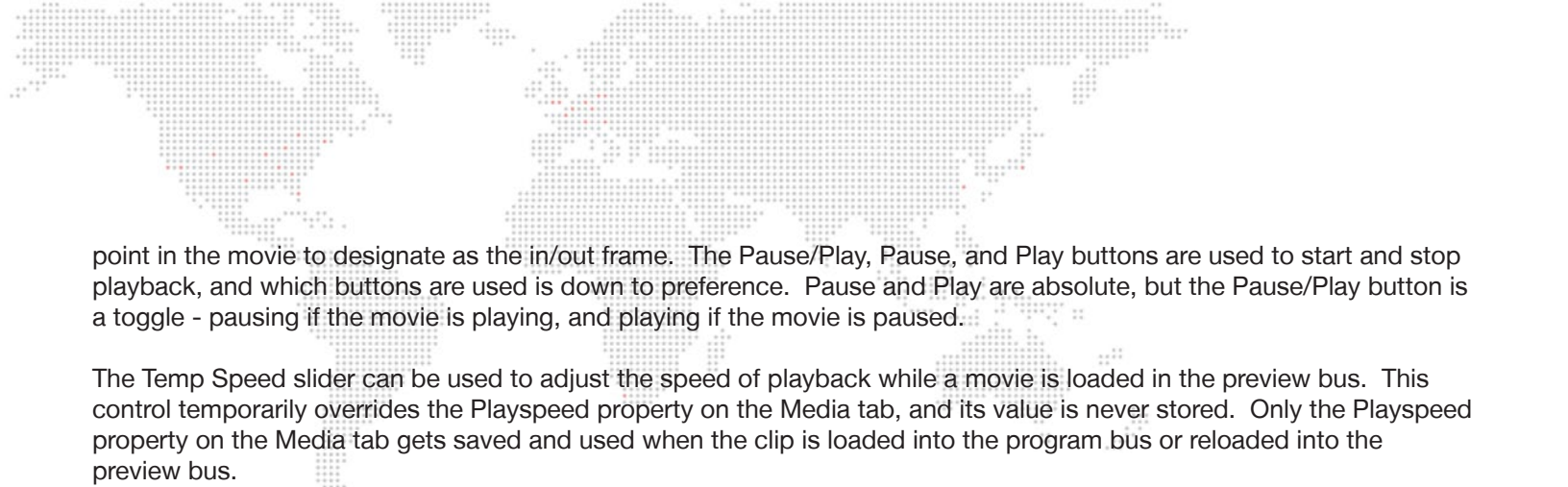

point in the movie to designate as the in/out frame. The Pause/Play, Pause, and Play buttons are used to start and stop playback, and which buttons are used is down to preference. Pause and Play are absolute, but the Pause/Play button is a toggle - pausing if the movie is playing, and playing if the movie is paused.

The Temp Speed slider can be used to adjust the speed of playback while a movie is loaded in the preview bus. This control temporarily overrides the Playspeed property on the Media tab, and its value is never stored. Only the Playspeed property on the Media tab gets saved and used when the clip is loaded into the program bus or reloaded into the preview bus.

A scrub bar is located below the playback buttons and includes a horizontal slider with green and red markers. The width of the scrub bar represents the full length of a movie (before in/out frames properties are changed) and the “thumb” of the slider represents the playhead position.

When the Play button is pressed, the thumb will move along the scrub bar from left to right, in time with movie playback. When clicked and dragged, the thumb can be used to scrub the playback position forwards and backwards. When the movie is scrubbed it will pause automatically after the thumb is released.

The green and red markers are used to both indicate and set the In and Out Frame properties for the clip. If the sliders or Set In/Out Frame buttons on the Media tab are used to modify a clip’s in/out frame, the markers will move automatically. Alternately, clicking and dragging on the markers will a. pause the movie, b. scrub the movie to the point where the marker is, and c. set the corresponding property to that point in the movie. This is different from the sliders on the Media tab in that those sliders do not pause and scrub the movie when they are adjusted.

Audio Playback

If a clip has sidecar or embedded audio, or is a standalone audio clip, no audio will be heard when the clip is playing in the preview bus.

Furthermore, the length of the clip and/or the length of sidecar audio may affect the duration of the clip when it is played. Refer to [“Playback Duration of Audio”](#) on page 59 for more information about the playback of standalone audio and sidecar audio, and the effect that movie or audio clip length may have on the duration of the clip.

Keyboard Shortcuts in Preview Bus

There are several keyboard shortcuts that work to control playback in the preview bus:

- + **Toggle Play/Pause** (Preview Bus only): [option space]
- + **Bump Left** (Preview Bus only): [option ←]
- + **Bump Right** (Preview Bus only): [option →]



PROGRAM BUS - SHOW OUTPUT

Overview

The program bus provides the show output playback for Mbox Player. Whereas clips are viewed and can have their properties edited “in private” while in the program bus, as soon as a clip is loaded into the program bus it is visible (or audible) on the show output display that is connected to the computer. As such, it’s arguably the most important part of the application - without a program bus there would be no show output.

The program shares the same controls for modifying the properties of a clip when it is loaded into the bus. Any changes to properties will be automatically stored and recalled the next time the clip is loaded into the either the preview or program bus. But the most important distinction is that any changes made to the clip while it is in the program bus will immediately be visible on the show output.

For this reason, it is not typical to make changes to clip properties while the clip is loaded into the program bus. However, the controls exist to allow clips to be tailored specifically for the show output (e.g. if cropping is required) or to cover emergencies during show playback.

Adjusting Clip Properties

Each clip property can be adjusted in exactly the same manner as it can be adjusted in the preview bus. Refer to [“Preview Bus - Adjusting Clip Properties”](#) on page 47 for more information. All changes to clip properties are stored with the clip in exactly the same manner as when adjusted in the preview bus. This means that any changes made in the program bus (even if intended to be temporary) will be recalled the next time the clip is recalled. Therefore, care should be taken if using the controls in the program bus for “real-time” adjustments to clips.

The playback controls in the program bus also work in exactly the same way as those found in the preview bus.

The only difference in controls between the preview and program buses is the addition of the Audio Level indicator and the Mute button in the program bus. These two controls can be used to monitor the approximate audio output level and to stop all audio output.

CAUTION! If the Mute button is pressed, the muting is not cleared when new clips are loaded into the program bus. All audio output from subsequent clips in the program bus will be muted until the button is pressed again to unmute the audio.

Keyboard Shortcuts in Program Bus

There are several keyboard shortcuts that work to control playback in the program bus:

- + **Toggle Play/Pause** (Program Bus only): [control option space]
- + **Bump Left** (Program Bus only): [control option ←]
- + **Bump Right** (Program Bus only): [control option →]



MANUAL OVERRIDES

Overview

At times, the predetermined end-of-clip actions specified in the clip list may not be the right course of action as the show progresses. Changes in show sequencing, unexpected stops and starts, or time constraints can mean that the link action stored in the clip need to change to a loop or freeze.

During cue-to-cue sessions or rehearsals it can be a useful tool to skip to the end of a clip in rehearsals so that transition moments can be tested and refined. Or during a live session it may be necessary to jump to the next clip before the current clip has finished, requiring an early “take” of the clip in the preview bus. And if an unplanned blackout is needed, the Kill button allows the output of the program bus to be quickly sent to black.

The controls in the Action/Override area provide the means for these situations to be handled quickly and with grace.

Take and Kill Timing

Immediately above the Take and Kill buttons are sliders that control the timing of the fades and/or transitions that happen when either of the buttons is pressed. There are two sliders above the Take button, one for Take Fade Out timing and the other for Take Crossfade/Cut/Delay timing. There is one slider above the Kill button that controls the Kill Fade Out timing.

Note: The action/timing defined by the position of these sliders is only used when the Take or Kill buttons are pressed, and not when a clip uses the predetermined end-of-clip action specified in the clip list.

Take:

- + **Take Fade Out** - if the Take Crossfade/Cut/Delay slider is not set as a crossfade (see below), this slider is visible and sets the fade out time of the clip in the program bus before it is replaced by the clip in the preview bus. After the fade out, the clip in the preview bus will replace the clip in the program bus using the cut or delay specified by the Take Crossfade/Cut/Delay slider.
- + **Take Crossfade/Cut/Delay** - this slider sets the transition type and timing between the program clip and the preview clip
 - If the slider is left at its default, center position, a 0 second cut will happen after any fade out set by the Take Fade Out slider.
 - If the slider is moved to the left of its default position, a crossfade of 0.1 to 5.0 seconds will happen. (In this case, the Take Fade Out slider is disabled and hidden.)
 - If the slider is moved to the right of default, a delay in black of 0.1 to 5.0 seconds will happen after any fade out set by the Take Fade Out slider.

Kill:

- + **Kill Fade Out** - if the Kill button is pressed, the clip in the program bus will fade to black using the time set by this slider. The program bus will then be cleared and the clip in the preview bus will not be loaded into the program bus.

Goto In, 10, 20, 30

If the clip in the program bus is a movie, the Goto buttons can be used to immediately jump the playhead to a predetermined point in the movie - the in frame, or 10, 20, or 30 seconds before the out frame. Following which, when the movie reaches its out frame it will follow the predetermined end-of-clip action that was specified in the clip list.

As an alternative to clicking on the Goto buttons with the mouse, keyboard shortcuts can be used: [i] for Goto In, [option 1] for Goto 10, [option 2] for Goto 20, and [option 3] for Goto 30.

IMPORTANT! In Mbox Player v1.0, the Goto 10, 20, and 30 keyboard shortcuts did not require the [option] key to be pressed. In Mbox Player v1.1 and beyond, the [option] key must also be pressed to perform these actions. This change has been made to support direct clip number entry for loading clips into the preview bus. Refer to [“Loading a Clip into the Preview Bus”](#) on page 47 for more information regarding direct clip number entry.

End-Of-Clip Overrides

In the area between the Take and Kill buttons are the controls used for overriding the end-of-clip actions that are assigned to a clip using the controls in the clip list. These controls only appear when a clip is loaded into the program bus and the state of the buttons and slider are always updated when a new clip is loaded into the program bus.

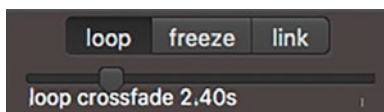

Loop with Crossfade

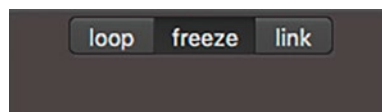

Freeze

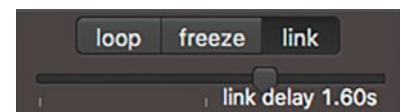

Link with Delay

Essentially, whenever a clip is loaded into the program bus for show output, Mbox Player reads the end-of-clip action that was assigned in the clip list and then automatically depresses the correct button - Loop, Freeze, or Link - and if the action is a loop or link, sets the slider to show the predetermined timing for the action.

If no further action is taken, when the clip in the program bus reaches its out frame, it will use the action assigned in the clip list. However, by pressing a different button and/or moving the slider, it is possible to change the end-of-clip action of the current clip. When it reaches its out frame, it will use the override action instead.

Note: Overriding a clip's end-of-clip action using the override controls does not permanently modify the end-of-clip action assigned in the clip list.

After the transition from one clip to the next, no matter whether the end-of-clip action was overridden or left untouched, the controls will always be updated to reflect the end-of-clip action for the next clip (assigned in the clip list).

REMOTE CONTROL VIA OSC

Overview

Beginning with version 1.1, the Mbox Player application is able to receive OSC commands for remote control. This functionality expands the application's ability to be controlled from a device or location that isn't the Mbox Player computer itself. The OSC functionality also allows for more control beyond the trigger actions that the Mbox Player Sync application can send.

Configuration

OSC input to Mbox Player must first be configured on the OSC tab of the application's preference window. By default the OSC input will be disabled, click on the checkbox to enable OSC. Once OSC is enabled, the input and output port numbers can be configured, and a check for feedback loops enabled.

Below the configuration options, detected OSC services will be shown in a list (toggle OSC off then on again to refresh the list). These devices may be connected to any active network interface on the computer, and their IP address will be shown to the right of their name. The device being used to send OSC messages to Mbox Player may appear in this list depending on whether or not it supports OSC discovery.

Below the detected OSC services is text area that by default displays a short list of OSC syntax examples, and below that a button that reveals more OSC syntax examples. Whenever an OSC command is received, the text area will show the received message (input) count, the last received message, and a count of any OSC feedback messages that Player has sent (output). This area can be useful for troubleshooting. If OSC commands are being sent but Mbox Player is not responding, check here to see if the OSC commands are being received and/or if their syntax is correct.

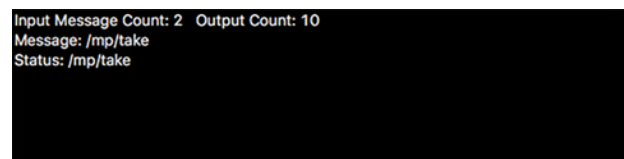
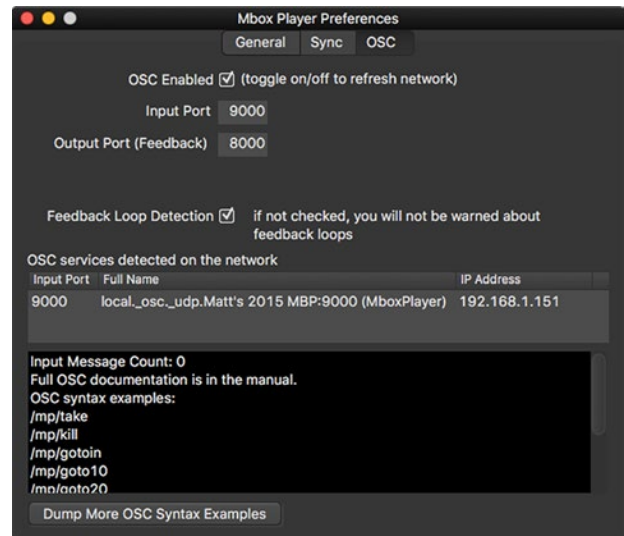

Note: Mbox Player supports OSC output, but only as feedback to a connected controller, and not as any configurable output commands.

Supported OSC Commands

Mbox Player supports quite a few OSC commands, but the core functionality is to load clips into the preview bus, take clips, and also kill clips. The most common commands are shown here, and also refer to the chart on the following page for a complete list of commands. All OSC commands to Mbox Player must use the correct syntax, where commands are always prefaced by “/mp/” as a reference Mbox Player.

- + **Take** - /mp/take
- + **Kill** - /mp/kill
- + **Goto In** - /mp/gotoin
- + **Goto 10** - /mp/goto10
- + **Goto 20** - /mp/goto20
- + **Goto 30** - /mp/goto30
- + **Next** - /mp/next
- + **Previous** - /mp/prev
- + **Load Clip by Number** - /mp/clip/#
- + **Load Clip by Number and Take** - /mp/go/#

Supported OSC Commands

Path	Value Range	Description
/mp/take	n/a	Takes the clip that is currently loaded into the preview bus
/mp/kill	n/a	Kills the clip that is in the program bus
/mp/gotoin	n/a	Sets playhead to in frame in program bus
/mp/goto10	n/a	Sets playhead to 10 seconds before out frame in program bus
/mp/goto20	n/a	Sets playhead to 20 seconds before out frame in program bus
/mp/goto30	n/a	Sets playhead to 30 seconds before out frame in program bus
/mp/next	n/a	Selects the next clip in the clip list and loads it into the preview bus
/mp/prev	n/a	Selects the previous clip in the clip list and loads it into the preview bus
/mp/clip/#	0 - 9999.99	Loads a clip from the clip list into the preview bus, clip is selected by its clip number
/mp/go/#	0 - 9999.99	Loads a clip from the clip list into the preview bus then immediately takes that clip, clip is selected by its clip number
/mp/menu/fullscreen	n/a	Toggles the Mbox Player application in/out of fullscreen mode
/mp/menu/hidemboxplayer	n/a	Hides the Mbox Player application
/mp/menu/quitmboxplayer	n/a	Quits the Mbox Player application
/mp/menu/newclip	n/a	Opens the file dialog for adding clips to the clip list
/mp/menu/locateclip	n/a	Opens the file dialog for locating/replacing a clip in the clip list
/mp/menu/duplicateclip	n/a	Duplicates the selected clip in the clip list
/mp/menu/openshow	n/a	Opens the file dialog for opening a show
/mp/menu/saveshow	n/a	Saves the current show
/mp/menu/saveshowas	n/a	Opens the save-as dialog for the current show
/mp/menu/showlogfile	n/a	Opens the log file for the Mbox Player application
/mp/menu/showpreferences	n/a	Opens the preferences window for the Mbox Player application



TIPS AND TRICKS

Helpful Hints When Using Mbox Player

- + Multiple clips can be selected at one time (for deletion or replacement) by using a [shift] or [⌘] click action when selecting.
- + Most property values for a clip can be dragged and dropped from individual parameter items on the tabs in the preview bus and program bus areas onto any other clip in the clip list to copy those property values to the other clip.
 - This is accomplished by dragging a single property value or by dragging the entire tab: click and drag on the name of the property or the name of the tab.
 - Clip fade in and fade out times cannot be dragged at present time.
- + To change the clip that is loaded into the preview bus, click on a different clip in the clip list, or use the up [↑] or down [↓] arrow keys on the keyboard to select the previous or next clip in the list.
- + If a clip has been given a clip number in the clip list, the number and period keys on the keyboard can be used to type in a clip number. One second after the last number is entered, if there is a clip with a matching number it will be loaded into the preview bus.
- + To completely clear the clip that is loaded into the preview bus, either click on the “Clear Preview” text label at the bottom of the clip list, or hit the left arrow [←] key on the keyboard.
- + While a clip is loaded and playing in the program bus, it is still possible to modify its end-of-clip action and the timing for those actions.
 - If the clip has reached its out frame and frozen, clicking on the loop checkbox will cause the clip to loop back to its in frame and start playing again.
 - If the loop or link timing is modified, the changes will be used when the clip reaches its end.
 - Use the override buttons and slider to apply a temporary end-of-clip action.
- + It is possible to load the same clip into both the preview bus and the program bus:
 - If parameter values are changed in the program bus, the changes will be stored and applied to immediately to the clip that is playing and to the preview bus.
 - If parameter values are changed in the preview bus, the changes will be stored and applied to the clip that is playing in the program bus the next time it reaches its loop point (if looping) or the next time it plays (if not looping).
- + Beginning in Mbox Player v1.3, auto side-car audio files are created automatically when a movie with embedded audio that used LPCM audio encoding is added to the clip list. There is no further action required to have this audio play when the movie plays.



AUDIO FILE PLAYBACK AND OUTPUT

Overview

In addition to visual imagery, Mbox Player can play both audio that is embedded in movie files or sidecar/standalone audio files. Audio can be output from the computer using any of the following interfaces or devices:

- + The computer's internal speaker.
- + The computer's line out or headphone audio jacks.
- + USB or FireWire audio interfaces connected to the computer.

Embedded Audio Tracks (in Movie Clips)

IMPORTANT! Mbox Player will always automatically play audio that is embedded in a movie.

Guidelines:

- + Embedded audio tracks can have up to eight audio channels (e.g. they can be stereo or multichannel).
- + Multichannel audio output requires the use of a USB/FireWire audio interface device that is selectable as the default audio output device in the System Preferences > Sound pref pane.
- + Embedded audio tracks should use AAC audio encoding if possible.
 - Unfortunately, AAC encoding presents an issue with multichannel audio, as most media creation applications cannot embed more than two channels of AAC audio into QuickTime movies.
 - Starting with Mbox Player v1.3, if a movie with embedded LPCM (uncompressed) audio encoding is added to the clip list, Player automatically makes an "auto-sidecar" audio file that is associated with the clip. No further action is required to make an auto-sidecar file play when the movie is played. Auto-sidecar files use the .caf file extension and are placed in the same location as the associated movie file. These .caf files should not be deleted, as doing so may result in no audio playback when the associated movie clip is played.
- + For best results use 48 kHz sampling. A bitrate of under 320 kbps is recommended.
- + For any clip having more than two audio channels the audio channels must be formatted in the appropriate manner.
 - Audio channels in QuickTime movies can be set to specific channel assignments. These assignments include the standard channels - Left, Right, Center, etc. - and also what are called "Discrete" channels. For best results with multichannel audio in Mbox Player, the audio channels should be assigned to the Discrete channels 0 through 7 (i.e. the first eight discrete channels). Alternately, the standard channels can be used, but must be assigned in the correct order: Left, Right, Center, LFE Screen, Left Surround, Right Surround, Left Center, Right Center.

CAUTION! Beginning in 2019, Adobe's latest media creation/conversion applications no longer create/export QuickTime movies with embedded audio that uses AAC encoding. Alternate movie encoding methods (e.g. FFmpeg) may be used, otherwise sidecar audio can be used instead.

Standalone and Sidecar Audio Files

Mbox Player can play "standalone" audio files if they are added to the clip list in the same manner as adding a movie or still image file. Or, audio files can be associated with an existing movie or still image clip in the clip list as a "sidecar" audio file.

Guidelines:

- + Standalone/sidecar audio tracks can have up to eight audio channels (e.g. they can be stereo or multichannel).
- + All audio output will be through the audio device that is selected as the default audio output device on the System Preferences > Sound pref pane.
- + Multichannel audio output requires the use of a multichannel USB/FireWire/Thunderbolt audio interface.
- + Standalone/sidecar audio tracks can use the AAC, AIF/AIFF, M4A, MP3, or WAV audio formats.
- + For best results use 48 kHz sampling. A bitrate of 320 kbps or less is recommended.
- + Auto-sidecar files are created automatically and do not have to be added to the clip list as sidecar audio files for an existing clip.

To add a standalone audio file to the clip list:

- Step 1. In the clip list, select the clip that you want to precede the new standalone audio file. Then click the plus button at the top of the clip list and select the audio file in the dialog that follows.
- Step 2. Alternately, just drag and drop an audio file from the Finder onto the clip list. Make sure not to drop the audio file directly onto an existing clip (which is considered a replace action).



To add a sidecar audio file to an existing clip (movie or still image) in the clip list:

- Step 1. Right-click on the existing file in the clip list and select the option “🎵 Set Sidecar Audio File for Clip” from the menu that appears.
- Step 2. Select the desired audio file in the dialog that follows.



Playback Duration of Audio

Prior to the modification of the in/out frame values for the clip, audio duration in Mbox Player may be affected by whether the audio is embedded, standalone, or sidecar.

- + Embedded audio is always the same duration as the movie it is embedded into. Unless the clip's in/out frame values are changed, all audio will play.
- + Standalone audio files are given their native duration automatically when added to the clip list. Clip in/out frame values can be changed to modify the audio duration and which portion of the audio plays.
- + Sidecar audio files get a duration based on what type of clip they are added to, after which the clip's in/out frame values are factored in:
 - When sidecar audio files are added to a movie clip, the length of the movie can affect the duration of the audio. Audio and video will always start at the same time, but if the movie is shorter than the audio, any extra audio will get clipped. If the movie is longer, there will be a corresponding period of silence at the end of the movie.
 - Still images and text files automatically get a duration of 36 minutes, 24 seconds, and 14 frames when added to the clip list. But the duration of still image and text files will change automatically if a sidecar audio file is added to them. The clip's new duration will be equal to the duration of the audio file.

Audio Output Volume Control

The clip volume property in the preview/program bus areas can be used to adjust the volume level on a per-clip basis. Only audio playing in the program bus will be audible, there is no audio output from clips playing in the preview bus. The Mute button on the program bus can be used to immediately stop all audio output from Mbox Player. And finally, the volume level of the computer's audio output device will also affect the audio volume - e.g. output level can be increased or decreased using the computer's volume controls.

WARNING! If the Mute button in Mbox Player's program bus is pressed, all audio output will be muted until either the button is pressed again or Mbox Player is quit and relaunched. Taking a new clip does not reset the state of the Mute button!

Selecting an Audio Output Device

Getting Mbox Player to play audio does not require any preferences to be set within the application, but in order for the resulting audio to be audible, the desired audio output device must be selected as the system default in the computer's System Preferences > Sound pref pane before the Player application is launched.

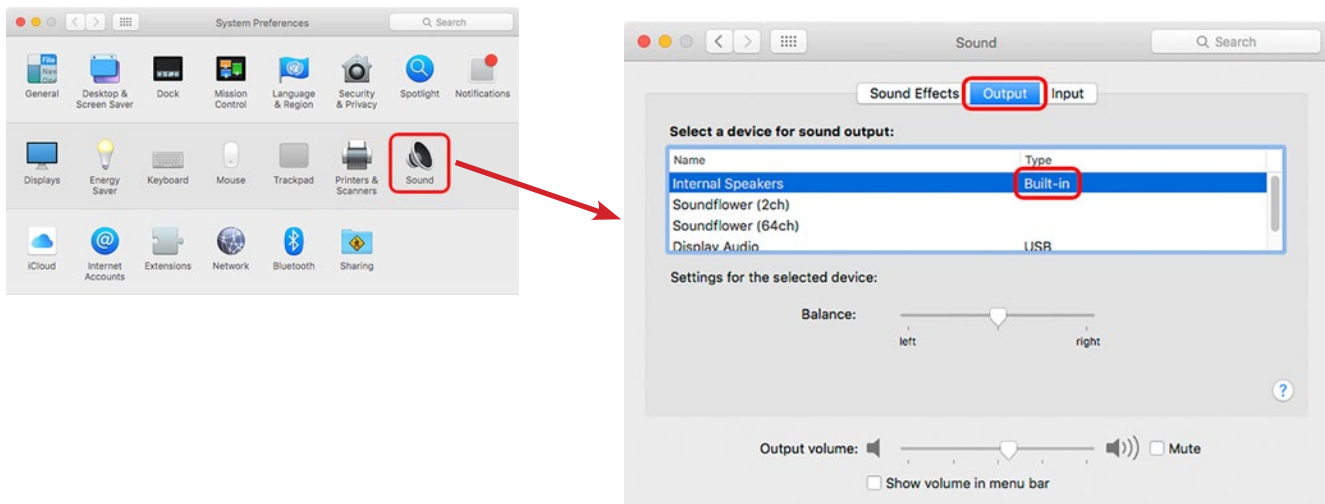

Note: The audio output device used by Mbox Player is the same as the OS default selection made in the System Preferences > Sound pref pane. Therefore, it is advisable to disable OS sound effects and volume change feedback on the Sound Effects tab of the Sound pref pane.

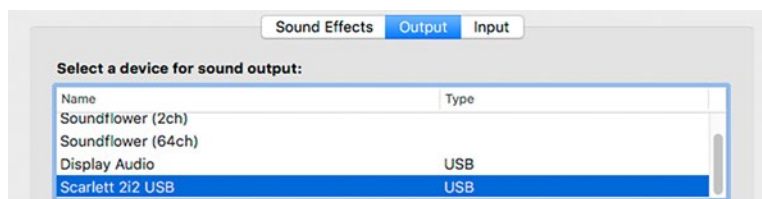

Opening the Sound pref pane and clicking on the Output tab will reveal a list of available output devices. The “Built-in” or “Internal Speakers” option will cause Player to use the computer's built-in speakers. Selecting an alternate output device (e.g. a USB/Audio interface) will cause that device to be used instead.

WARNING! If the OS default audio output device is changed while Mbox Player is running, the Player application must be quit and relaunched for the change to take effect. If the selected device is removed while Player is running, audio output from Mbox Player will cease until the Player application is quit and relaunched.



5.

MBOX PLAYER SYNC

This chapter contains information on the Mbox Player Sync application, which allows one or more Player Sync computers to be remotely triggered.

- + **MBOX PLAYER SYNC APPLICATION**
- + **CONFIGURATION**
- + **TRIGGERING PLAYBACK REMOTELY**

MBOX PLAYER SYNC APPLICATION



Playback Synchronization

In show situations where more than one video output is required or where a backup device is required, there must be more than one computer running the Mbox Player application. When running more than one instance of Mbox Player it may be desirable to both trigger playback actions (e.g. Load, Take, and Kill) on multiple servers at the same time, and also to synchronize the actual playhead positions on the servers.

The Mbox Player Sync application sends commands and a master sync clock time to Mbox Player over an Ethernet network. The Player Sync application can run either directly on an Mbox Player computer or on some other computer that is networked to one or more Player computers. Note: There are relevant preferences that must be set on Player's preference window (Refer to "[Preferences Window](#)" on page 32).

Note: Typical operation for Mbox Player Sync is to trigger playback on multiple Mbox Player computers at the same time. It is not typical practice to run the Player Sync application on a Player computer to trigger playback only on that computer, as Player's user interface already supports this.

Mbox Player Sync Application User Interface

The Mbox Player Sync application has a single window that includes several interface elements. There are two pop-ups for setting preferences, a text display to show the current master sync clock time, and six buttons for trigger actions.

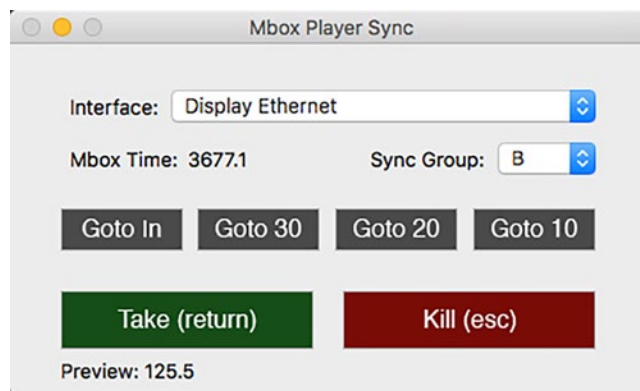

- + **Interface** - Selects the network interface that the Player Sync application uses to output sync commands and master sync time to connected Mbox Player computers. The pop-up shows all currently active interfaces on the computer. If an interface was previously selected for use, but is now inactive, its name will be shown in gray rather than black.
- + **Sync Group** - Selects the sync group that the application will use when sending command and master sync time to receiving Mbox Player computers. Sync Groups A through H are available
- + **Mbox Time** - Displays the master sync clock time as a decimal number. This value is shown for informational purposes only and can be compared to the received sync clock time on the Mbox Player application.
- + **Trigger Buttons** - These buttons are used to trigger the corresponding command on the receiving Mbox Player computers. Commands are sent instantly, but only to the Sync Group selected. As an alternative to clicking on these buttons with the mouse, keyboard shortcuts can be used: [i] for Goto In, [option 1] for Goto 10, [option 2] for Goto 20, and [option 3] for Goto 30.
- + **Load Clip by Number** - As in the Mbox Player application, a numbered clip can be loaded into the preview bus by typing its clip number on the keyboard. The clip will be loaded after a one second delay to allow typing to finish.



CONFIGURATION

Overview

The Mbox Player Sync application must be configured correctly to be able to trigger commands on connected Mbox Player computers. There are three configuration items to be aware of: network interface, sync group, and delay. The first two items are configured in the Player Sync application itself, and the third item is configured in the Mbox Player application on the Mbox Player computer.

Network Interface

The Mbox Player Sync application must use an active Ethernet network interface on the computer. This interface can be any interface on the computer, including the localhost. Available interfaces will be shown using black text when the pop-up is clicked on. Any previously-selected interface that is no longer available will be shown using gray text and cannot be selected.

WARNING! Seeing the interface name displayed in gray text is an indication of an error in that the interface is no longer active. Either the interface must be made active, or a different interface must be selected.

No matter which interface is selected, that interface must be able to communicate with the selected network interface on the Mbox Player computer. This means two things - the two network interfaces must be on the same physical network and they must be on the same subnet. Refer to Appendix A for more information on proper IP Address and Subnet Mask settings for computers on the same subnet.

If the Mbox Player Sync application is running on an Mbox Player computer:

- + If Player Sync is only controlling the local instance of Mbox Player, the network interface can be set to “Local”. Typically this setup is not used as the local instance of Mbox Player can be controlled using the buttons in the Player application itself.
- + If Player Sync is controlling both a local instance and also remote instances of Mbox Player, the network interface selected must be the interface that connects to the remote Mbox Player computers.

Sync Group

In addition to selecting the correct network interface for commands to Mbox Player computers, the Mbox Player Sync application may need to have the Sync Group set to some value other than the default (“A”). The ability for Player Sync to output to multiple different sync groups and to have the Mbox Player application select which sync group it listens for allows multiple instances of Player Sync to run on the same network with each instance sending commands and sync to a unique sync group.

If only one sync group is required, both Mbox Player and Mbox Player Sync can be left at the default sync group value. Otherwise use additional sync groups as required.

WARNING! It is not possible to run more than one instance of the Mbox Player Sync application on the same computer. Separate instances must run on separate computers!

It is possible to have two active instances of Mbox Player Sync on the same network subnet, with both instances sending commands to the same sync group. This setup is not necessarily an error condition but can be used for backup purposes. The receiving Mbox Player computers will only respond to commands from the instance of Mbox Player Sync that appeared first on the network. If this arrangement is maintained and the first instance goes offline, the Mbox Player computers in that group will start responding to commands from the remaining instance of Player Sync.

The Mbox Player Sync application also sends the master sync clock time to receiving Mbox Player computers. As with the triggering commands, the master sync clock time is sent to the selected sync group.

Delay

An important feature of the Mbox Player application is its ability to apply a variable delay to all triggering commands received from the Mbox Player Sync application. The delay amount is configurable on the Mbox Player computer only, as it may be variable between computers, based on their location or purpose. The delay can be set anywhere from 0 to 10,000 milliseconds (mS) which equates to 0 to 10 seconds.

The delay can be used to counteract differences in latency between the video outputs of different Player computers, or to apply a specific delay to a backup computer or supplemental playback sources.

Note: The delay set in Mbox Player only affects the delay used when responding to trigger commands and not the master sync clock. This is by design as the sync clock does not need to be delayed.

TRIGGERING PLAYBACK REMOTELY

Configuration

To remotely trigger Mbox Player from another computer using Mbox Player Sync, configure the network interfaces on both computers, then connect physical network equipment (cables/switches) as required. Launch the appropriate application on each computer, setting the preferences for network interface, sync group, and delay as required.

IMPORTANT! The keyboard shortcuts for Goto 10/20/30 have changed between v1.0 and v1.1! Refer to [“Trigger Buttons”](#) on page 62 for details.

Triggering Playback

Seven different commands can be sent from the Player Sync application to Mbox Player. These commands act exactly the same as pressing the corresponding button(s) in the user interface for Mbox Player on the receiving computer. The only difference being the application of the delay as noted above. The seven commands that can be sent are: Take, Kill, Goto In, Goto 10, Goto 20, Goto 30 and the Load Clip by Number command.

As when it is used in the Mbox Player application, the Load Clip by Number command has the following action:

- + Using the keyboard to enter numbers and the period key for a decimal point will load the clip with the matching number into the preview bus - after a one second pause to allow numbers to be entered.
- + If the Take button or [return] key is pressed during clip number entry or within one second of entry, the clip with the matching number will be loaded and then immediately taken.

Due to the master sync clock time provided over the network by the Mbox Player Sync application, Mbox Player also knows the master clock time. When a triggering command is sent from Player Sync, it receives a timestamp using the master sync clock time. When the command is received by Mbox Player, it is acted upon at that same time plus any delay time as configured in the Mbox Player application’s preferences.

Note: Triggering commands are only timestamped when they are sent from the Mbox Player Sync application. No commands are sent when the Mbox Player application loops or links clips on its own. Therefore, if a clip is triggered using Player Sync, when that clip loops there is no re-syncing and playback may start to drift slightly. At this point playback is being controlled by the local computer’s clock, which is not in sync with the local clock of other computers. To resync playback, another command needs to be sent from the Mbox Player Sync application.



6.

CONTENT CREATION AND UTILITIES

This chapter contains information on the proper formatting of content for playback with Mbox Player, as well as content conversion.

- + **CREATING CUSTOM CONTENT**
- + **MEDIA CONVERSION APPLICATION**



CREATING CUSTOM CONTENT

Movies

Mbox Player will try to play any QuickTime movie - no matter what codec it may be - however, movies that are formatted incorrectly may not play at all or may not play as well as movies that are formatted correctly. While Player will do the best job possible to play any compatible movie content, if the file is not optimized specifically for Mbox Player, poor results may occur. There are many elements of movie files that need to be considered when creating content: file extension, codec, compression, frame rate, resolution, and audio. The following sections take an in depth look at each of these requirements.

The Mbox Player application uses AVFoundation technology as the basis for its playback engine. The QuickTime Player application on the Player computer also uses AVFoundation technology. QuickTime Player will also attempt to open any movie file, but will display a prompt if the file has to be converted before playback. As a general rule of thumb, Mbox is capable of playing any file that the QuickTime application on the Mbox computer can open and play without conversion.

Note: QuickTime Player cannot open movies files that use the Hap codec, whereas Mbox Player can.

File Extension

QuickTime movies can have all sorts of file extensions. But in Mbox Player, only movie files with the .mov or .mp4 file extensions can be added to the clip list. Furthermore, even though Player will *try* to open and play a movie because it uses one of these two file extensions, this does not guarantee that the movie *will* play! It is a good idea to always test all movie files in advance.

Codec

A movie's codec (coder/decoder) is very important. When a movie is added to the clip list, Mbox Player will try to play any QuickTime movie that has the correct file extension, no matter what its codec is. However only movies using the Apple ProRes, Photo-JPEG, H.264, or Hap codecs can actually play. Within that list of codecs, ProRes, Hap, and Photo-JPEG codecs are considered to be "preferred codecs." Movies that use one of these three preferred codecs can benefit from the enhanced playback performance from the Mbox playback engine.

Note: The ProRes and Hap codecs do not need to be installed on the computer to allow Mbox Player to play movie encoded using any version of ProRes or Hap. However they must be installed to allow the Mbox File Convertor application (see page 71) to convert movies into one of those codecs.

The ProRes codec should typically be the first choice when creating content for Mbox Player. Photo-JPEG and Hap will work well, although there are some additional considerations that must be taken into account when using these two codecs. Movies created using any other codecs may not play as well as movies using a preferred codec:

- + Apple ProRes is a high-quality, spatially compressed, scalable codec that was designed to compress HD content sufficiently to keep bitrates at SD levels. Decompression of ProRes can be multi-threaded, providing better performance on computers with multiple CPU cores. ProRes is currently the best choice of codec for use with Mbox Player unless the computer is of a low specification. The bitrate of ProRes content can be very high, and care should be taken when creating movies in this format.
- + Photo-JPEG is another quality, scalable format that uses spatial compression. Photo-JPEG movies can be of any resolution within the performance limits of the computer. Photo-JPEG is processor-intensive, so care must be taken to use a reasonable quality setting or playback may not be smooth. Typically, a quality setting of Medium or 60%-80% is appropriate. A quality level above 80% will have not improve the quality of the image as displayed by Mbox Player.

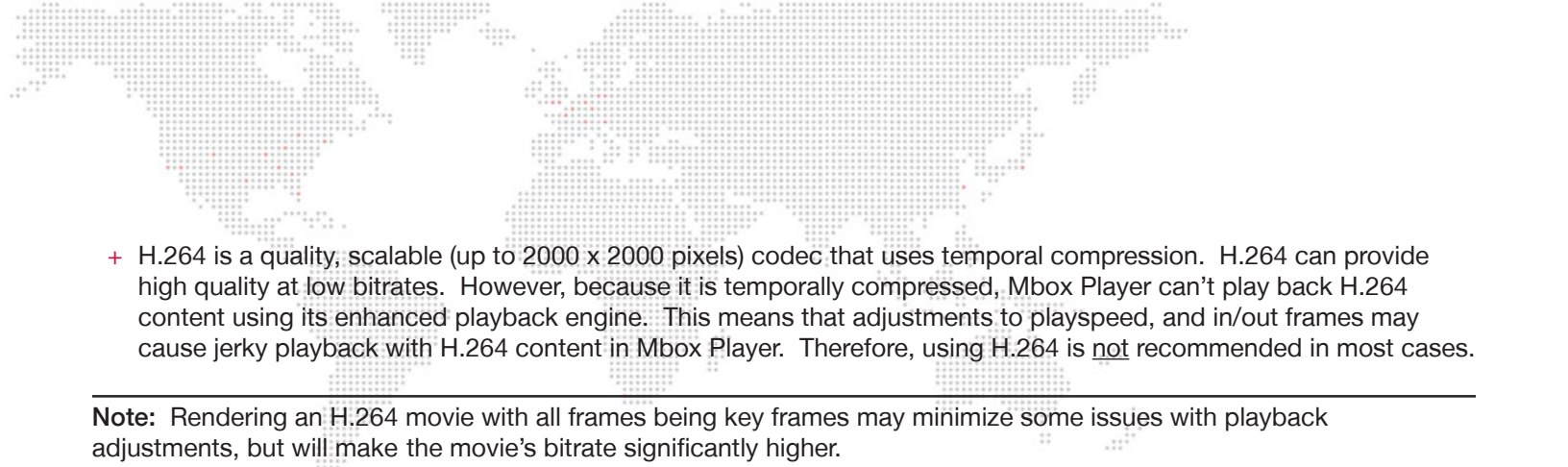
- 
- + H.264 is a quality, scalable (up to 2000 x 2000 pixels) codec that uses temporal compression. H.264 can provide high quality at low bitrates. However, because it is temporally compressed, Mbox Player can't play back H.264 content using its enhanced playback engine. This means that adjustments to playspeed, and in/out frames may cause jerky playback with H.264 content in Mbox Player. Therefore, using H.264 is not recommended in most cases.

Note: Rendering an H.264 movie with all frames being key frames may minimize some issues with playback adjustments, but will make the movie's bitrate significantly higher.

- + In Mbox Player, the Hap codec is decompressed on the GPU rather than on the CPU. This can allow computers with fewer/slower CPU cores to have better performance than with other codecs. A powerful graphics card is recommended to make best use of movie encoded with the Hap codec. Hap movies can have a high bitrate and therefore require a fast disk with good bandwidth.

Compression (Bitrate)

Movie compression can have a large impact on playback performance. There is a balance between quality and performance that can be tipped in either direction by adjusting the amount of compression when a movie is rendered. Typically, compression is labeled as "Compressor Quality" or something similar and the scale goes from "least" to "best" or 0% to 100% - more compression to less compression.

With higher compression, a movie file will be smaller (on disk) and its bitrate (or data rate) will be lower. Exclusive of other performance bottlenecks like decompression and rendering time, lower bitrates can lead to better playback if the Mbox computer's hard-drives are slow. But with too much compression the resulting movie quality may become unacceptable. Reducing the amount of compression can provide a higher quality movie, but due to the higher bitrate, playback performance may suffer unless the computer has a fast hard-drive (SSD or flash-based).

Another factor to consider when thinking about compression is the computer's ability to decompress the movie. Most codecs require the CPU to perform all the work involved in decompression. A computer with a larger quantity of faster CPU cores can make a difference, as can codecs like ProRes that can be decompressed on more than one core at a time. The Hap codec can make use of the computer's GPU to perform the decompression task, thereby reducing the load on the CPU but increasing the load on the GPU.

Under normal circumstances, when deciding between higher or lower compression, there will be a point of diminishing returns where either quality or playback becomes unacceptable. A movie with a low quality setting might play well, but look unacceptable to the eye. And conversely, very high quality settings may not look noticeably better but can suffer from poor playback performance.

As a rule of thumb, movie bitrates should be kept below 150Mbits/sec, but in special circumstances, Mbox Player can handle bitrates up to approximately 300Mbits/sec.

Frame Rate

Movie frame rate must be considered when creating content for Mbox Player. For the best results in typical usage, content should be rendered at a frame rate that is exactly one-half of the refresh frequency of Mbox Player's show output. e.g. If the connected display device has a 60 Hz refresh, movies that play at 30 fps will synchronize exactly with the output to the display.

While content with high or lower frame rates can be used, there may be some noticeable effects depending on the frame rate. In the above example, if the movie has fewer than 30 fps, then the Graphics card will periodically need to repeat some frames and the movie would appear to play less smoothly. Depending on the frame rate of the movie or the motion in the movie's imagery, this effect may be more or less noticeable.

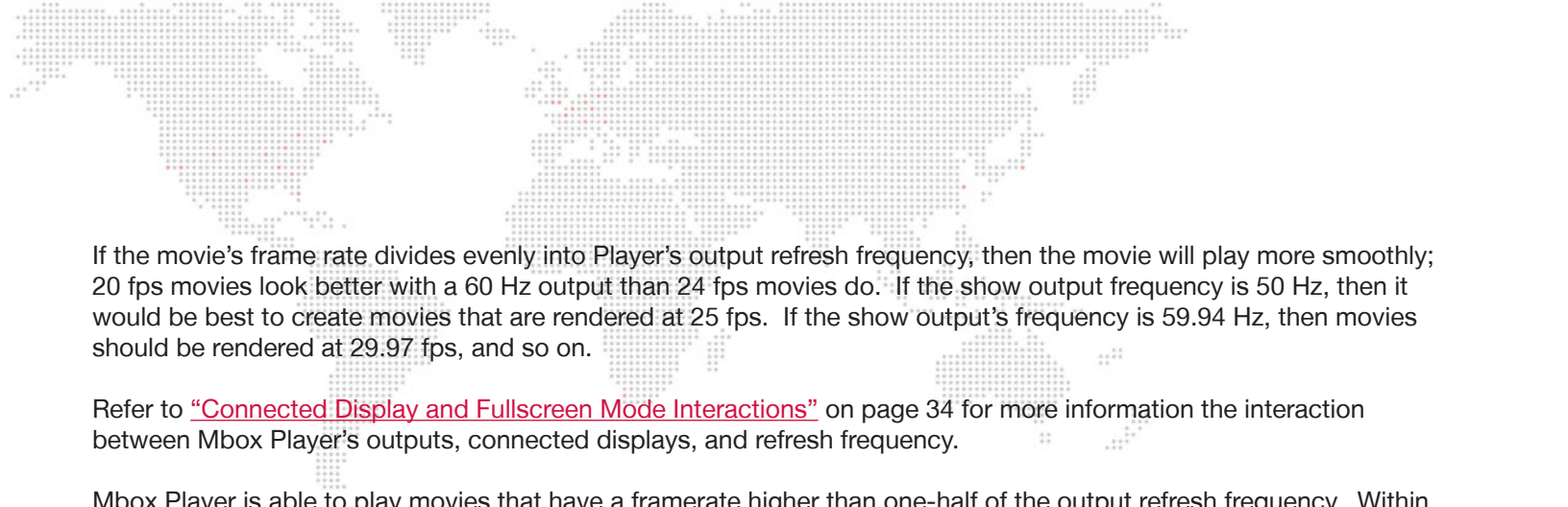

If the movie's frame rate divides evenly into Player's output refresh frequency, then the movie will play more smoothly; 20 fps movies look better with a 60 Hz output than 24 fps movies do. If the show output frequency is 50 Hz, then it would be best to create movies that are rendered at 25 fps. If the show output's frequency is 59.94 Hz, then movies should be rendered at 29.97 fps, and so on.

Refer to [“Connected Display and Fullscreen Mode Interactions”](#) on page 34 for more information the interaction between Mbox Player's outputs, connected displays, and refresh frequency.

Mbox Player is able to play movies that have a framerate higher than one-half of the output refresh frequency. Within the performance limits of the computer hardware, higher framerates may provide smooth playback if they are exactly the same as, or a multiple of, the refresh frequency. If the show output refresh frequency is 60 Hz, then movies can have a frame rate of 60 fps or 120 fps, and so on. However, Mbox Player can only *display* a number of frames per second matching the refresh rate of the show output. Therefore, there is little point to attempting to play a movie made with 120 fps as a full one-half of the frames will not be displayed if the show output refreshes at 60 Hz.

Note: In most situations, based on connected show output display device, the maximum refresh frequency for the Mbox Player computer will be 60 Hz. In which case, the maximum frame rate for movie content should be 60 fps.

Generally all custom content for a specific show is rendered using the same framerate; all movies for one show would be 30 fps, rather than some being 30 fps and others being 29.97 fps. Therefore, it's important to ensure that the video output from the Mbox Player computer uses a refresh frequency that is a multiple of the movie framerate.

Resolution

Movie resolution - the movie's dimensions in pixels - has an impact on the performance of Mbox Player. To put it simply, the larger the movie's pixel dimensions, the harder it is to play. For best results, always try to play the smallest movie possible. Of course, there are factors outside of Player that need to be taken into consideration when choosing a content resolution - type of output signal, display device native resolution, size of projection surface - but for the most part, there is not much point in playing content that has a higher resolution than the display device it will be viewed on. But admittedly, sometimes the smallest possible movie is not the one that looks the best with every particular setup, so make sure to test in advance if possible.

Mbox Player does not have any limit to the resolution of movie or still image content. As long as the computer's hardware can support reading the imagery from the hard drive, decompressing it, and rendering it then that content is fine. In real-world conditions, 4K resolution (3840 x 2160 pixels) is about the largest useful size for content for best performance results.

Alpha Channel in Movies

Mbox Player can display movies and still images that have areas of transparency. However, because Player doesn't do any compositing of multiple layers of imagery, it makes no sense to intentionally render content with an alpha channel.

ProRes 4444 and Hap Alpha Codecs

When creating content, there are quite a few QuickTime codecs that allow an alpha channel (transparency information) to be embedded in a movie. For the purposes of Mbox Player, the only available codecs are ProRes 4444+, Hap Alpha, and Hap Q Alpha. Encoding content using one of these three codecs (especially ProRes 4444) can result in movies having a very high bitrate. This, coupled with the fact that Mbox Player doesn't make use of the alpha channel information, means that using content with an alpha channel is not recommended.



Still Images

Mbox can play back several different still image file types. JPEG, PNG, TIFF are the three recommended types, and of those three, PNG is probably the best. JPEG has reasonable quality, TIFF can have very high quality (uncompressed quality) but the file size can be very large and PNG manages to have good quality and also keeps the file size reasonably small.

There are a few guidelines for still images:

- + Resolution - use the smallest image possible that provides the desired quality result when scaled for the show output. Using an overly large image and scaling down doesn't provide better results than using a correctly-sized image. Scaling an image up can reduce quality quite quickly.
- + Quality/Compression Level - use a quality that displays the image accurately, but which keeps the file size manageable and allows Mbox to display the image without any latency between the Take button being pressed and the image appearing onscreen.
- + Color depth - Player can open and display still images using both 8-bit and 16-bit color. However, all files are rendered onscreen using 8-bit color. Therefore, for normal purposes, there is no advantage to using 16-bit files.
- + Colorspace - the colorspace profile of still images in Mbox Player is important. Whenever possible, make sure to use the sRGB profile when saving still images (i.e. assign the sRGB profile to the image and make sure the profile is embedded in the image when saved). If a different color profile is used, the still images will not have accurate color.

Audio

Audio file creation for Mbox Player requires consideration during the content creation process. Player can play audio that is embedded within the QuickTime movie or can use sidecar/standalone audio files. (Refer to [“Audio File Playback and Output”](#) on page 58 for more information)

Mbox Player can play audio directly from a QuickTime movie that has an embedded audio track. For Mbox Player to play embedded audio directly from a file, the embedded audio must use AAC audio encoding. However, starting with Mbox Player v1.3, Player automatically makes sidecar files for movies with embedded audio using LPCM encoding. These “auto-sidecar” files are placed in the same folder as the associated movie and require no additional action to play when the movie is played.

Recommendations for embedded audio encoding:

- + Sample rate: 48 kHz
- + Bitrate: 320 kbps
- + Number of channels: 1 or 2 (mono or stereo)

Mbox Player can also play the audio from a sidecar/standalone audio file (e.g. non-embedded audio or no movie required). Sidecar and standalone audio files have fewer restrictions on the type of audio encoding used, and can use the AAC, AIF/AIFF, M4A, MP3, and WAV audio formats.

Recommendations for sidecar/standalone audio encoding:

- + Sample rate: 48 kHz
- + Bitrate: 320 kbps
- + Number of channels: 1 to 8
- + File extensions: .aac, .aif, .aiff, .m4a, .mp3, .wav



Text Files

Mbox Player can display text using RTF (Rich Text Format) files. The RTF format results in high quality text and allows the ability to change the font, size, style, and color.

.rtf

The simplest way to create an RTF file is to use the TextEdit application on the Mac computer. Start a new document, make sure the text formatting is using rich text (this is the default for TextEdit) and then type in some text. Save the file as a Rich Text Document using the .rtf file extension.

Guidelines for RTF files:

- + The paper/background color used in the RTF file is ignored - the background color will always be black in Mbox Player.
- + The font color used in the RTF file is taken into account. For specific font colors, choose a font color when creating the RTF file, then save that with the file.
 - For flexibility, make the font color white in the RTF file, then use the color controls in Mbox Player to subtract red, green, or blue from the clip.
 - If the font color is black in the RTF file, the text will not appear unless the color controls are used to add red, green, or blue to the clip.
- + The font(s) saved in the RTF file will be used when the clip is opened in Player. But only if that font is installed on the computer used.
- + Avoid using multiple fonts on the same line of text as this will affect vertical justification.
- + Keep font sizes large, then scale the clips in Player as required.
- + Left/Right/Center justification in the document is ignored. For left/right alignment, use spaces in the text instead.

Applications for Content Creation

There are many applications that can be used to create or edit content for Mbox, varying from the high end (Adobe After Effects®, Apple Final Cut®) to the low end (QuickTime® 7 Pro). Each has different strengths, but there are some guidelines to be observed:

- + Never create a movie with compressed headers or prepare a movie for internet streaming.
- + Do not use QuickTime 7 Pro to change the framerate of a movie and trim the movie at the same time, as this will modify the headers of the QuickTime file to the point where Mbox Player cannot play it. However, QuickTime 7 Pro can be used to convert a movie from one codec to another or to trim an existing movie. It is recommended that more complex tasks be performed using some other application, such that the movie's source elements are re-rendered into a new file. This is especially critical if the movie has audio tracks.
- + Mbox Player can play back H.264 content using either the QuickTime (.mov) or MPEG-4 (.mp4) container formats.
- + Avoid including extraneous tracks (e.g. timecode) in QuickTime movies if at all possible.
- + Avoid including embedded audio in movies that should not have any audio output.
- + Mbox Player renders onscreen with 8-bit color; there is no advantage to creating content with a higher color depth.
- + To create content using some codecs (e.g. ProRes and Hap), the codec must be installed on the computer that makes the content, and the application must support the use of the codec. Newer versions of the Adobe suite and most applications on the PC may not support ProRes or Hap. Alternatives like FFmpeg can be used instead.



MEDIA UTILITY APPLICATIONS

AVF Batch Convertor

In some cases, Mbox Player may not be able to play custom QuickTime movie content. If a movie doesn't play or has poor playback, first confirm that the movie uses one of the Mbox Player preferred codecs. (Refer to [“File Type Specifications”](#) on page 22) If the movie is not using one of these codecs, it can be converted to a preferred codec using the AVF Batch Convertor application. If the movie is already using one of the preferred codecs, the AVF Batch Convertor application can be used to re-encode the movie in an attempt to eliminate the problem.

IMPORTANT! The AVF Batch Convertor application was created by the developers of the Hap codec and is being included for use with Mbox Player with their approval. While PRG has made minor changes to the application, all credit goes to Tom Butterworth and David Lublin of Vidvox LLC.

About File Conversion

The AVF Batch Convertor application will accept file drops of more than one movie file at a time. It processes one file at a time and will queue additional files. By default, the application creates a new copy of each original movie file in the same location as the original file. The new files cannot be converted and saved with the same name as the original in the same folder, and must have their name changed or must be saved to a different folder. A prefix can be added to the file name, or some trailing component of the file name removed and optionally a new trailing component added.

After conversion, be sure to replace the original files in the clip list with the newly converted versions, so the new version is used for playback. Remove the original files if the converted files are saved into the same folder as the originals. Refer to [“Replacing Content in the Clip List”](#) on page 41 for more information.

File Conversion Settings

There are multiple settings that can be modified when using the AVF Batch Convertor application with movies, these include: codec, quality, resizing, recompress/copy/strip video or audio tracks, resampling audio tracks.

- + **Recompress, Copy, or Strip:** The application can recompress video and audio tracks, copy them, or strip them. Different settings can be selected for the video and audio tracks,
 - Recompressing tracks will cause the original data to be re-encoded using the selected codec.
 - Copying tracks will cause the tracks to be copied over unaltered. It may be desirable to recompress the video track in a movie but leave the audio unaltered.
 - Stripping tracks will remove them from the resulting movie. This is generally only useful for audio.
- + **Codec:** This setting has eleven possible values: PJPEG, H264, five versions of the ProRes codec, and four versions of the Hap codec.
 - All movies to be converted will be converted to the selected codec. Files conversions to a different codec must be performed in a separate batch.

- + **Quality:** The adjustable quality slider setting only applies to movies when they are being converted to PJPEG, Hap, or Hap Alpha. H264, ProRes, Hap Q, and Hap Q Alpha use other controls
 - Generally you should use the highest possible quality setting that provides the desired playback result, but it may be necessary to test several levels of quality to get the desired results.
 - The ProRes codec has five preset quality levels. ProRes 422 will typically provide the best balance between quality and playability. Hap Q and Hap Q Alpha use fixed quality levels and may have very high bitrates, leading to poor playback on some systems.
 - The H264 codec allows the profile (baseline, main, high) to be set for varying quality levels, the frequency of key frames and the movie's data rate (bitrate) can be adjusted, and multi-pass encoding can be enabled.
- + **Resizing:** This setting allows the movie track to be resized when it is recompressed. The results of the resize may be unexpected in some cases depending on the content and selected codec, therefore it is recommended to avoid using this conversion.
- + **Audio Settings:** Audio can be stripped, copied, or recompressed. Stripping or copying audio is recommended over recompressing, as recompressing may have an undesired impact upon audio quality.
 - When recompressing audio, the resulting codec (AAC, LPCM, or Apple Lossless), bitrate strategy, and bitrate can be set. Mbox Player can handle either AAC or LPCM, but Apple Lossless is not recommended. A bitrate less than 320 kbps (around 128 - 192 kbps is fine) is best for use with Mbox. A sample rate of 48 kHz is the best choice for Mbox.
 - Only the LPCM audio codec can handle multi-channel (more than stereo) audio without issues, converting multi-channel audio from LPCM to AAC may result in the loss of the added channels of audio.

Note: Only Hap Alpha, Hap Q Alpha, and ProRes 4444 allow the movie to contain an alpha channel.

File Conversion Procedure

- Step 1. Locate the AVF Batch Convertor application in the /Applications/Mbox v4 Utilities folder. Double-click its icon to launch the application.
- Step 2. Press the import button to select files to be converted, or drag and drop files into the area below the import button.
- Step 3. Click the Settings button to adjust the video and audio recompression settings for the movie.
 - a. Select copy, strip, or recompress for video track as desired.
 - b. If recompressing video, select codec, quality, bitrate etc.
 - c. Select copy, strip, or recompress for audio track as desired.
 - d. If recompressing audio, select codec, bitrate, sampling rate.
- Step 4. Select the destination folder if not the same as the original. All converted files will be saved to this location.
 - a. If the destination folder is the same as the original, use the file renaming tools to adjust the name of the converted files.
 - b. The output area will show the names of the files to be converted, and the word "Ready" in green if the conversion can start. If the words "Already Exists" are shown for one or more files, the renaming must be used.



A.

NETWORKING FOR MBOX

This appendix provides guidelines for setting up Mbox networks.

+ MBOX NETWORKING GUIDELINES



MBOX NETWORKING GUIDELINES

Concepts

The majority of communications to and from Mbox use Ethernet protocols. This means that Ethernet networks route the data into the Mbox server and from the server to other connected devices. Because all of these protocols need to live in harmony, steps need to be taken to avoid interference between protocols, and to maximize the available network bandwidth/speed. Due to these requirements, it is recommended that the computer used as an Mbox server have more than one network interface. For more complex setups, three or four network interfaces may be preferable.

While all the network interfaces on a computer could be connected to the same network to gain some amount of additional bandwidth, doing so would bypass the desire to keep certain protocols separate. Therefore, it is much more useful if each network interface on the computer is configured for and connected to a separate physical Ethernet network. If multiple interfaces must be connected to the same physical network, then the network should have a system of VLANs enabled to help segregate different protocols.

Connecting more than one network interface to different networks is only the first step. Each interface needs to have its IP Address and subnet mask set correctly for the network that it is being connected to. Getting the IP Address and subnet mask correct ensures that communications to and from the computer will leave the computer through the correct interface and arrive at the intended destination without any ambiguity or loss of data.

Concept definitions:

- + **Network Interface** - the physical Ethernet connection (typically RJ-45) on the computer that a cable is connected to in order to connect the computer to a physical network.
- + **Network** - a group of devices connected to each other that can potentially communicate using Ethernet IP protocols. The word “network” describes not just the physical connection of multiple devices, but also the “web” of electronic communication between them.
- + **Subnet (subnetwork)** - a logical subdivision of a network such that multiple interfaces can be connected to the same physical network, but are placed on different subdivisions of that network for the purposes of routing or for keeping some communications separate. (Note: a subnet is not the same as a VLAN.)
- + **IP Address** - an interface property using the dot-decimal (e.g., 2.0.0.123) notation, where each of the four numbers separated by decimal points is referred to as an octet (because each is an 8-bit number). In combination with the interface’s subnet mask, the octets in the IP address designate either the device’s sub-network or the device’s unique identifier on that subnet.
- + **Subnet Mask** - a second interface property, also using dot-decimal notation (e.g., 255.0.0.0). The value of each octet in the subnet mask determines which of the octets in the device’s IP address specify the sub-network and which specify the interface’s unique identifier on that sub-network. The subnet is specified by setting one or more of the octets in the subnet mask to a value other than 0.

Subnet Masking Basics

For pretty much all communication to and from Mbox, each octet in an interface’s subnet mask will be set to either 0 or 255. Values other than 0 or 255 can be used for more complicated subnetting, but are typically not needed with Mbox and won’t be discussed here.

In order to understand how an interface’s subnet mask works, it needs to be viewed together with the interface’s IP address. If an octet in the subnet mask has a value of 255, then the corresponding octet in the interface’s IP address is used to designate the subnet that the interface belongs to. If an octet in the subnet mask has a value of 0, the corresponding octet in the IP address is used as part of the interface’s unique identifier on that subnet. Within the

structure of sub-networks and unique identifiers, it is possible to have multiple interfaces on the same subnet, each being uniquely identifiable. Data can be sent to all interfaces in the subnet by broadcasting, to groups by multicasting, or to individual members by unicasting.

How the IP Address and Subnet Mask Work Together

For a device with the IP address of 192.168.0.123 and a subnet mask of 255.255.0.0, the first two octets of the IP address “192.168” are used to specify the sub-network, and the last two octets “0.123” specify the device’s unique identifier within that network.

	Network		Unique ID	
Subnet Mask:	255	255	000	000
IP Address:	192	168	000	123

Depending on the number of octets with a value of 255 in the subnet mask, different descriptions may be given to the interface. A subnet mask of 255.0.0.0 leads to a description of “/8” for the interface. Combined with the interface’s IP address, this information would be written as “192.168.0.123/8”. A subnet mask of 255.255.0.0 gets a description of “/16” and 255.255.255.0 a description of “/24”.

Note: There is no such thing as a /32 subnet mask, as the last octet in an interface’s IP address must always be used as a unique identifier.

Routing Ethernet Communications

- + **Full Broadcast** - data packets that are sent to the full broadcast destination IP address (255.255.255.255) will be received by all devices on the physical network provided the packets are not blocked by a switch or router between devices. Full broadcast is akin to shouting in a crowded room. Everyone can hear the yelling, but must decide whether to listen or not. Full broadcast is simple and guarantees for the most part that every device on the network can get the data. However, it places a lot of data onto the network, thus using up more of the available bandwidth. Another downside is that receiving devices may need to spend more time than is desirable to filter out data that they don’t need to listen to.
- + **Subnet Broadcast** - packets that use a subnet broadcast IP address (x.255.255.255, x.x.255.255, or x.x.x.255) will only be received by interfaces on the matching subnet - i.e., those with a subnet mask that places them into the same subnet. This is one step down from shouting, as subnet filtering allows receiving devices to immediately discard any subnet broadcast data that isn’t destined for their subnet.

To obtain the subnet broadcast address for a particular subnet:

- Step 1. Take the IP address for a device on that subnet and the subnet mask for that device.
- Step 2. Line the address and subnet mask up one above the other, in four columns with each octet being a column.
- Step 3. In columns where the subnet mask has a value of 255, write down the value from the IP address’ octet.
- Step 4. In columns where the subnet mask a value of 0, write down a value of 255.

IP Address:	192	168	000	123
Subnet Mask:	255	255	000	000
Subnet Broadcast Address:	192	168	255	255

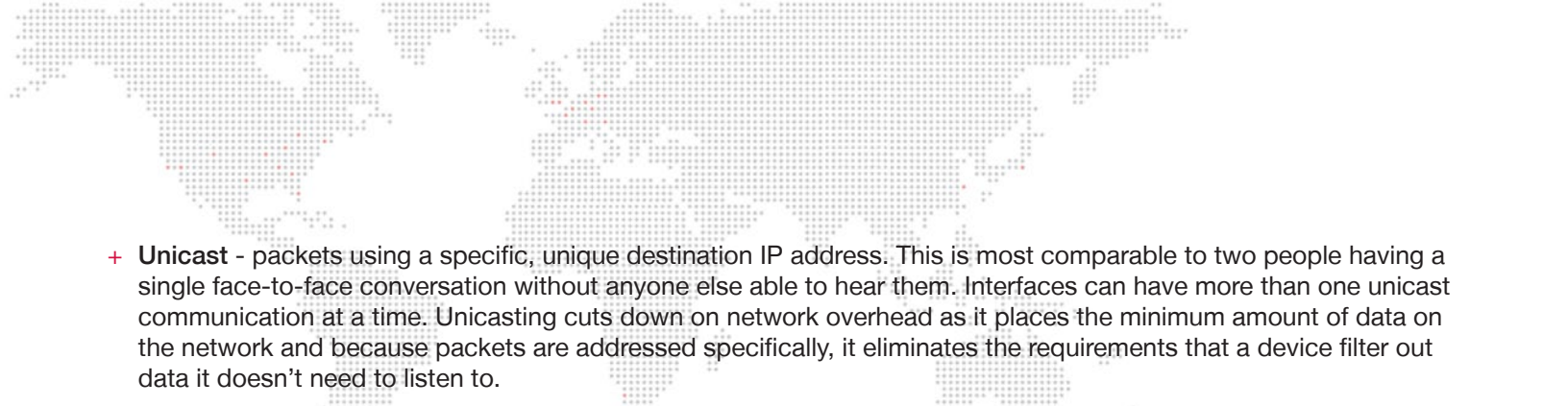
- 
- + **Unicast** - packets using a specific, unique destination IP address. This is most comparable to two people having a single face-to-face conversation without anyone else able to hear them. Interfaces can have more than one unicast communication at a time. Unicasting cuts down on network overhead as it places the minimum amount of data on the network and because packets are addressed specifically, it eliminates the requirements that a device filter out data it doesn't need to listen to.
 - + **Multicast** - packets that are sent to an IP address belonging to a predetermined range of IP addresses. Interface's may join a multicast group to be able to send and receive packets within the group. This is comparable to a group of listeners who all choose to listen to one speaker, or to other members of the group who take on the role as speaker. The conversation doesn't leave the group.

It is possible for interfaces to send packets to or receive packets sent to a multicast address without joining the corresponding multicast group. But unless the interfaces join the multicast group, switches between the devices may not forward the multicast packets correctly.

Most of the time a /8 subnet mask (255.0.0.0) can be used with Mbox. When using multiple interfaces on the same computer, with each having a /8 subnet mask, a general rule is to make sure that each interface has a different first octet. Otherwise there may be ambiguity when trying to determine which interface to use for various communications. While all interfaces on a computer may receive packets from any source, packets sent by the computer almost always should leave through only one interface. If that interface is not on the correct subnet (or indeed the correct physical network) then the packets will never get to the intended destination.

CAUTION! IP addresses starting with 2 and 192 and having a subnet mask of 255.0.0.0 are actually publicly routable IP addresses. Therefore, if the computer has an interface connected to a router (e.g. connecting to the internet), and also has an interface with a 2./8 or 192./8 then there may be some connection issues with certain websites.

For example, if two interfaces are configured with IP addresses of 2.0.0.1 and 2.1.0.1 and both have a subnet mask of 255.0.0.0. -> Both interfaces are on the same sub-network (i.e. 2.x.x.x), but have unique IDs on that network. Because this is a valid IP scheme, the computer will allow this; but using this setup will cause issues with Mbox software. One or both of these interfaces should use a /16 subnet mask instead of the /8 subnet mask, thereby placing the two interfaces onto different subnets. -> 2.1.x.x and 2.0.x.x

With all protocols, especially those detailed below, it's best that one and only one interface on the computer be on the same subnet as the destination devices. When the computer is told to output data to a specific destination device it avoids confusion if only one interface can "talk" to that device.



Standard Control Protocols

Art-Net

Art-Net packets can be fully broadcast (i.e., not restricted to a particular subnet) which makes a device's subnet inconsequential. Some Art-Net devices use full-broadcast to transmit their data, potentially flooding the network with data.

To reduce overhead, most Art-Net devices use a subnet mask of 255.0.0.0 and generally use either 002 or 010 as the first octet in their IP address. This places these devices into a specific subnet and they only talk to other Art-Net devices on the same subnet. Art-Net data would be sent to the subnet broadcast IP address - either 2.255.255.255 or 10.255.255.255. While this cuts down on some bandwidth usage vs. a full broadcast, it should be noted that subnet broadcasts still aren't the most efficient use of bandwidth.

For the best efficiency possible, Art-Net can be unicast from device to device. This cuts down on overhead, but means that the IP address for each device must be known in advance and the precise destination for every piece of data must be specified. This can make the hardware configuration and software setup more complex. Additionally, the device to be unicast to must still be on the same subnet as an interface on the Mbox computer, otherwise the packets won't be received at all.

sACN

sACN packets are typically multicast, which sidesteps the restrictions of subnets and subnet masks, meaning that any interface can send or receive data for any multicast group it joins. Of course, the interface must still be on the correct physical network for the multicast group. Joining a multicast group is most important when receiving data. Switches can monitor multicast data on the network, and then filter out data that a connected interface has not elected to receive (i.e. for a multicast group the interface has not joined).

Any interface on the computer can be used for multicast, but as noted earlier, the interface has to be specifically identified and registered as a member of the appropriate multicast group. sACN uses predetermined multicast groups, one for each sACN universe, with each group having a preset IP address. Without registering as a member of all of the necessary multicast groups (for transmitting or receiving), Mbox will not be able to send or receive sACN data. For the purposes of receiving multicast data, it is possible to have all the interfaces on a computer join a multicast group, so that the data is received no matter what interface it arrives on. But for the purposes of outputting multicast data, only one interface should join the group.

sACN does allow for broadcast or unicast but this functionality is not widely used.

KiNET

KiNET is intended to be unicast only. Therefore all packets are addressed to specific IP addresses. This is efficient, but as with Art-Net unicast, the user must know all of the IP addresses of the connected devices that they want to communicate with in advance. And as always, the Mbox computer must still have an interface that is on the same physical network and subnet as the receiving device.

Notes



INDEX



INDEX

A

Art-Net 77
Audio 69

C

Clip List 7, 26

- Adding Content 39
- Missing Content 43
- Reordering Clips 43
- Row Color 20

Clip Properties

- Color 28
- Geometry 28
- Media 28
- Playback Controls 29
- Scrub Bar 29
- Temp Speed 29

Clip Properties (Adjusting)

- Preview Bus 47
- Program Bus 52

Clips

- Adding 17, 39
- Copying and Pasting 41
- Missing Content 43
- Replacing
 - Multiple Clips 42

Computer/OS Setup 36

Content

- Creating Custom Content 66
- File Convertor 71
- Formatting 22
 - Alpha Channel 68
 - ProRes 4444 and Hap Alpha Codecs 68
 - Audio 69
 - Codec 66
 - Compression (Bitrate) 67
 - File Extensions 23, 66
 - Frame Rate 67
 - Movies 22, 66
 - Other File Types 22
 - Recommended Practices 23



- Resolution 68
- Still Images 22, 68
- Text Files 69
- Management 23

E

- End-Of-Clip Actions 45
 - Freeze 45
 - Link 45
 - Loop 45
 - Priorities 46

F

- File Converter 71

I

- Install 10

K

- Kill 31
 - Button 31
 - Sliders 31
 - Fade Out 31
- KiNET 77

L

- Licensing 13
 - Dongle 13
 - Soft-license 13
 - Activation 13
 - Deactivation 15
 - USB License Key 13

N

- Networking
 - IP Address 75
 - Subnet 74
 - Subnet Mask 75

P

- Performance 36
- Playback
 - End-Of-Clip Actions 45
 - Remote Triggering 64
 - Synchronization 62



Player Sync Application

Configuration 63

Delay 64

Network Interface 63

Sync Group 63

Playback Synchronization 62

Triggering Playback 64

User Interface 62

Interface 62

Mbox Time 62

Sync Group 62

Trigger Buttons 62

Preview Bus 7, 27, 47

Program Bus 7

Protocols

Art-Net 77

KiNET 77

sACN 77

S

sACN 77

Showfile

Open 38

Save 38

Show Output 8

EDID 34

Format 35

Subnet 74

Syphon

Output 8

T

Take 31

Button 31

Sliders 31

Crossfade/Cut/Delay 31

Fade Out 31

Text Files 69

U

User Interface

Action/Override Area 31

Application Windows 25

Clip List 7

Fullscreen Mode 25



Main Window

Action/Override Area	31
End-of-Clip Overrides	32
Goto Buttons	31
Take and Kill Buttons	31
Take and Kill Sliders	31
Clip List	26
Preview Bus	27
Program Bus	30
Preview Bus	7
Adjusting Clip Properties	47
Program Bus	7
Adjusting Clip Properties	52
Show Output	8
Window Mode	25