

N.A. TEAM DESCRIPTION	HINGE 15" LOWPRO BAT VERTICAL KIT
E-CODE	76546-
MANUFACTURER	PRG SCENIC
HINGE 15" LOWPRO BAT VERTICAL KIT CONTAINS ALL SUB KITS LISTED BELOW	
HINGE 15" LOWPRO BAT VERTICAL LEFT KIT	76546-100
HINGE 15" LOWPRO BAT VERTICAL RIGHT KIT	76546-200

76546-100 HINGE 15" LOWPRO BAT
VERTICAL LEFT KIT

76546-200 HINGE 15" LOWPRO BAT
VERTICAL RIGHT KIT

ANGLE SELECTION PIN
MOVE TO DESIRED ANGLE HOLE

ANGLE SELECTION PIN
MOVE TO DESIRED ANGLE HOLE

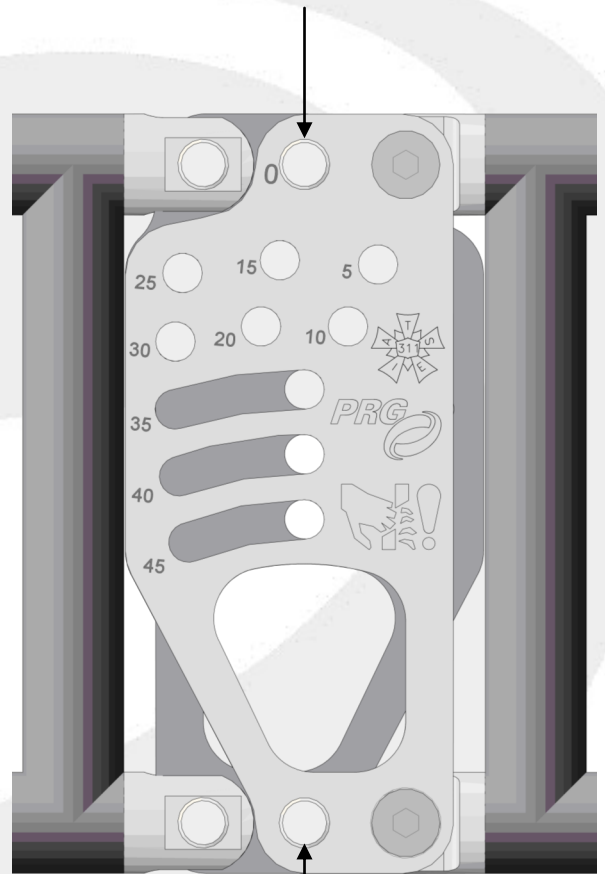
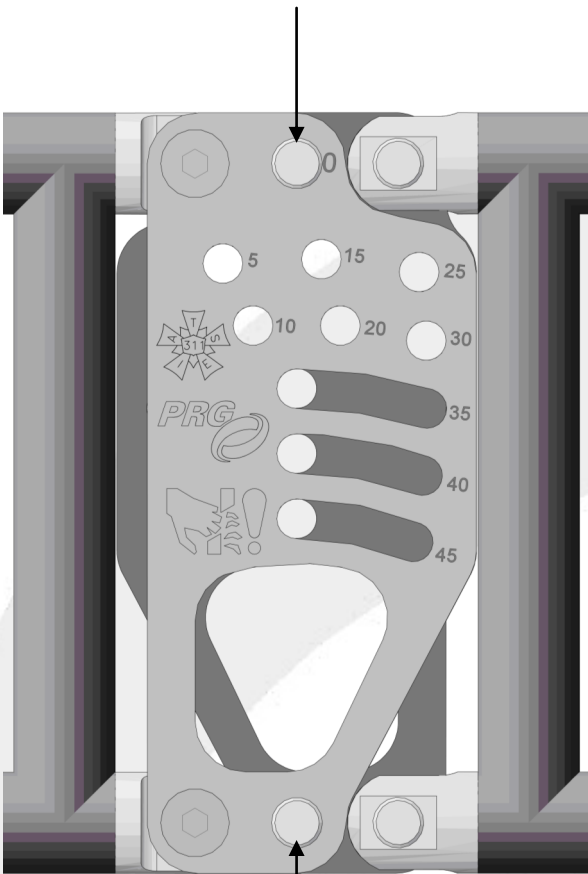

HINGE PIVOT PIN

HINGE PIVOT PIN

N.A. TEAM DESCRIPTION	HINGE 15" LOWPRO BAT VERTICAL LEFT KIT
E-CODE	76546-100
MANUFACTURER	PRG SCENIC
WEIGHT	24 LBS

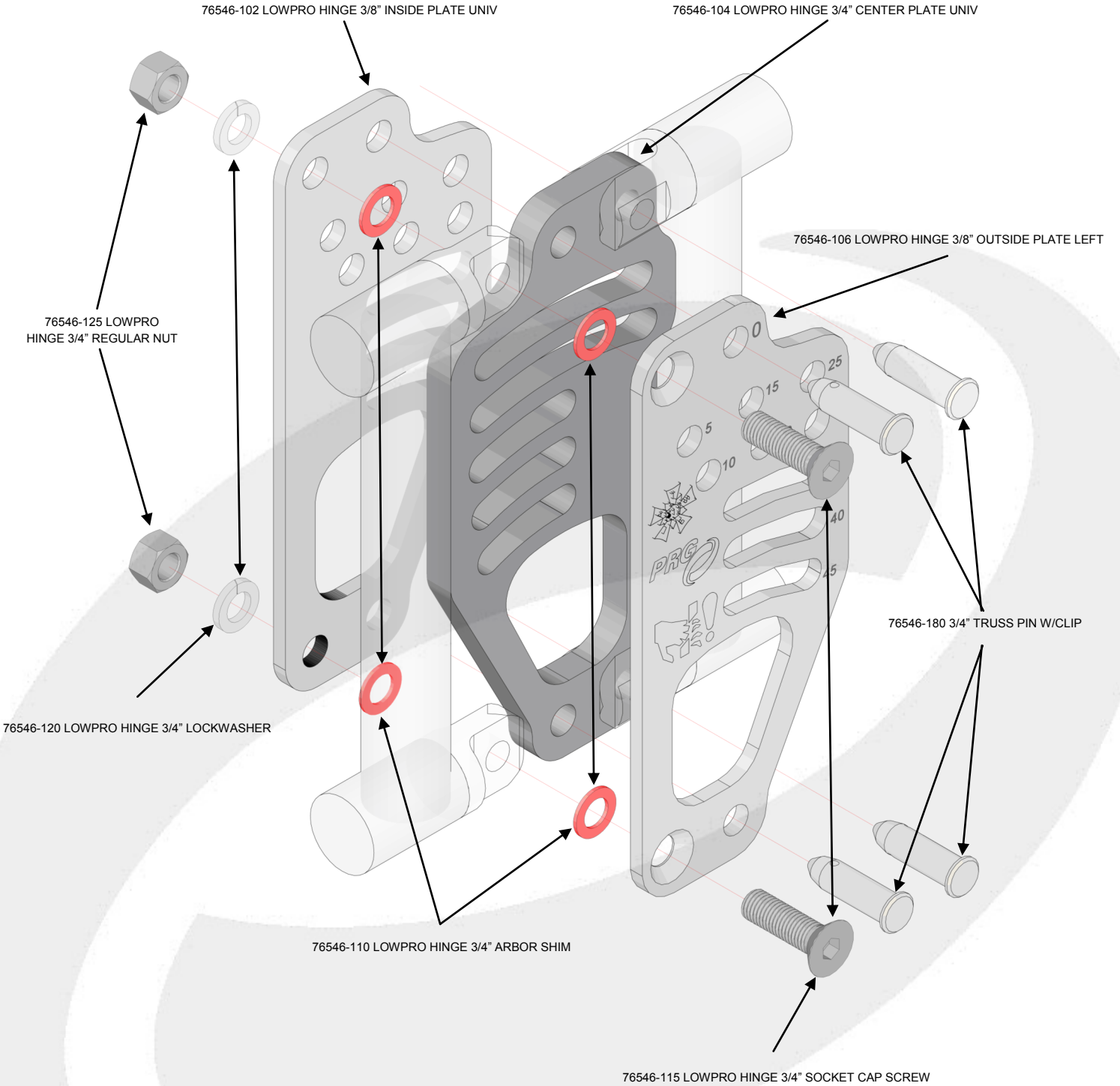

N.A. TEAM DESCRIPTION	HINGE 15" LOWPRO BAT VERTICAL RIGHT KIT
E-CODE	76546-200
MANUFACTURER	PRG SCENIC
WEIGHT	24 LBS

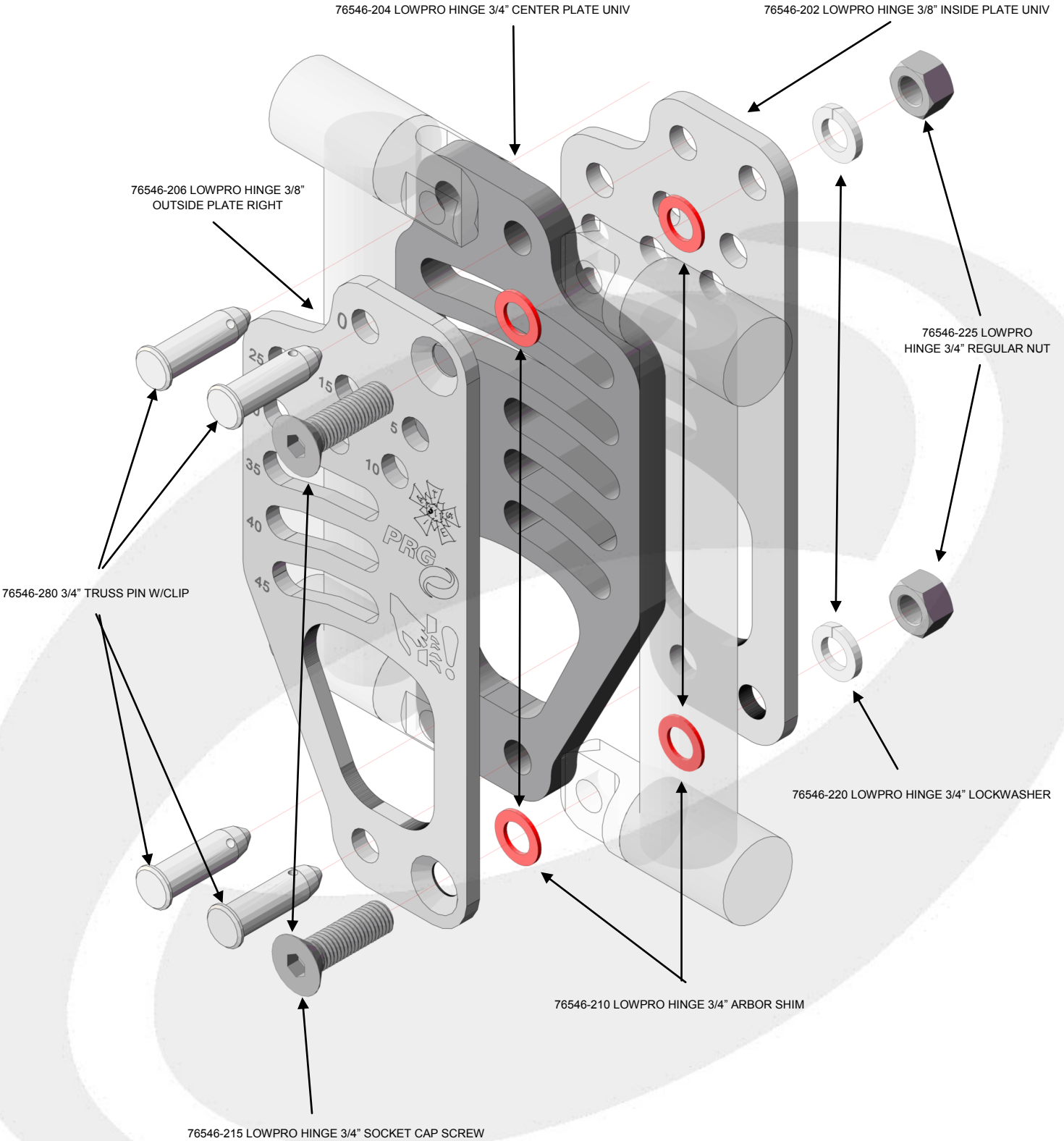

N.A. TEAM DESCRIPTION	HINGE 15" LOWPRO BAT VERTICAL KIT
E-CODE	76546-
MANUFACTURER	PRG SCENIC
HINGE 15" LOWPRO BAT VERTICAL LEFT KIT	76546-100
HINGE 15" LOWPRO BAT VERTICAL RIGHT KIT	76546-200
0-45 DEGREES IN 5 DEGREE INCREMENTS	

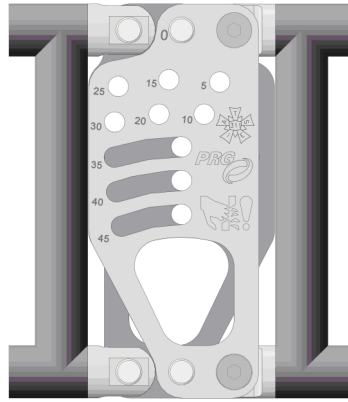

0 DEGREE PIVOT

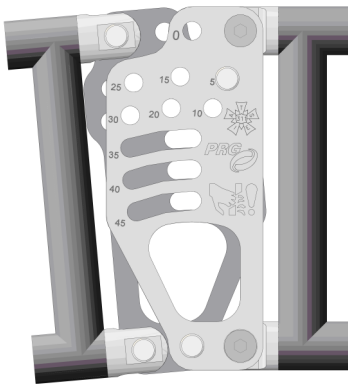

5 DEGREE PIVOT

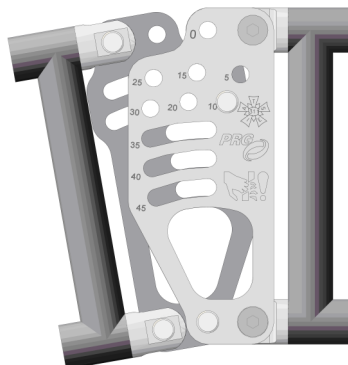

10 DEGREE PIVOT

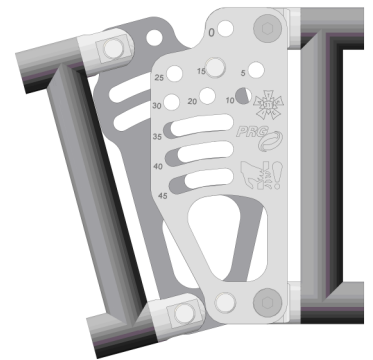

15 DEGREE PIVOT

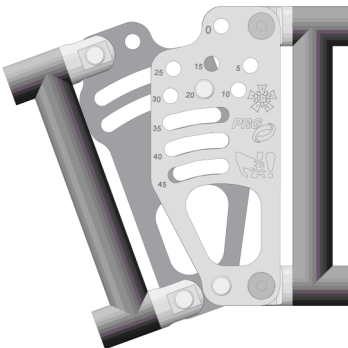

20 DEGREE PIVOT

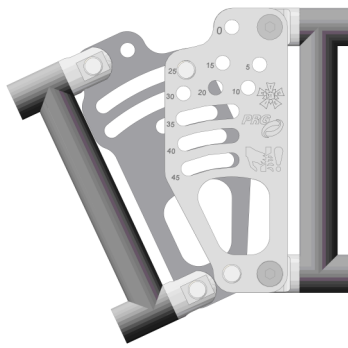

25 DEGREE PIVOT

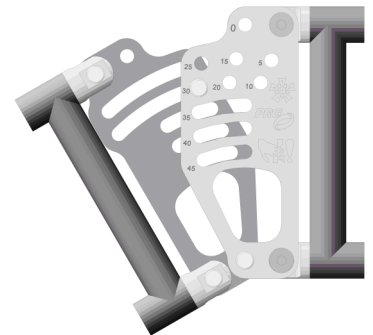

30 DEGREE PIVOT

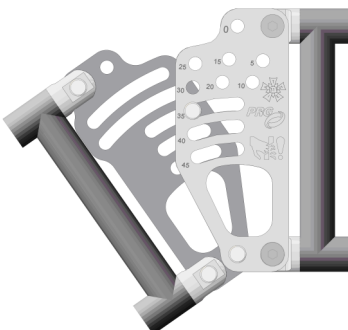

35 DEGREE PIVOT

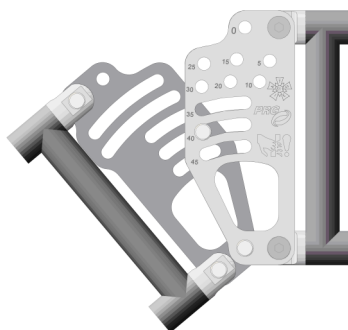

40 DEGREE PIVOT

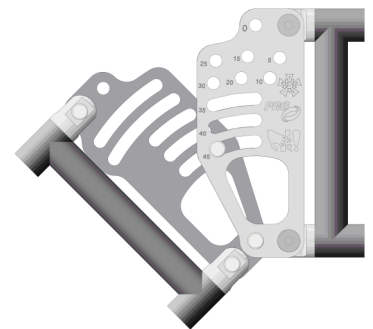

45 DEGREE PIVOT

N.A. TEAM DESCRIPTION	HINGE 15" LOWPRO BAT VERTICAL KIT
E-CODE	76546-
MANUFACTURER	PRG SCENIC
HINGE 15" LOWPRO BAT VERTICAL LEFT KIT	76546-100
HINGE 15" LOWPRO BAT VERTICAL RIGHT KIT	76546-200

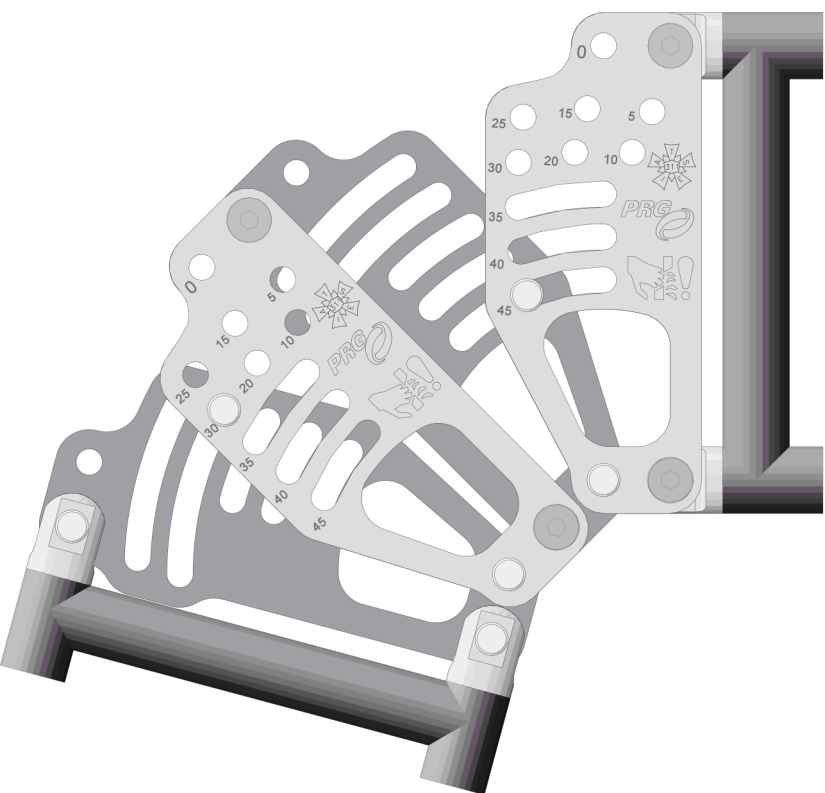
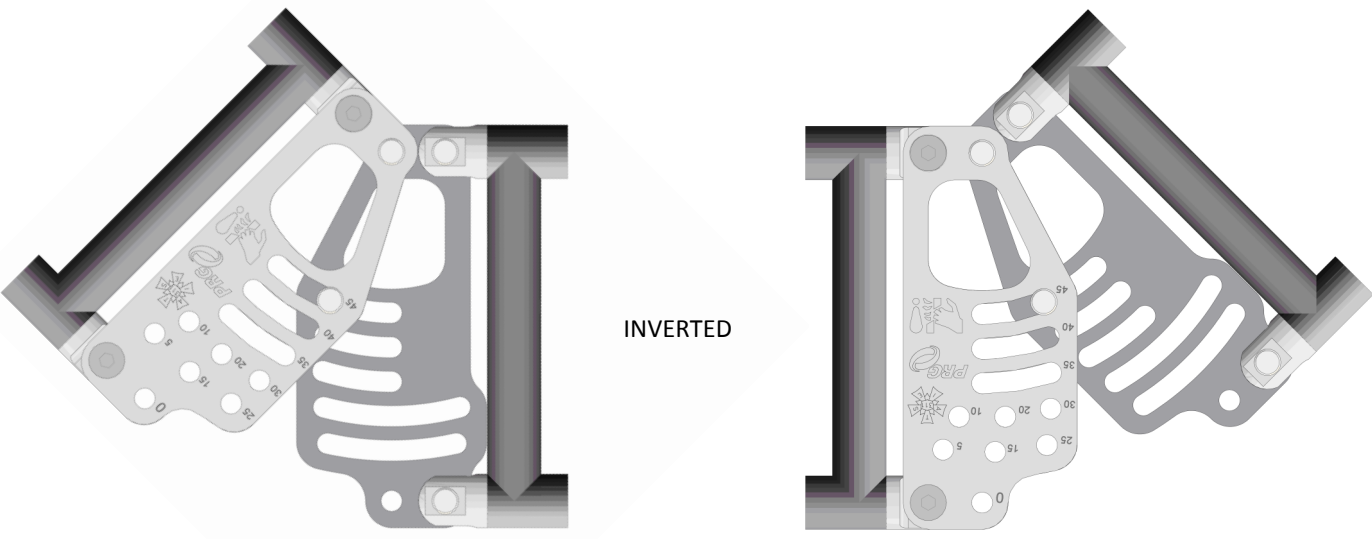

MULTIPLE HINGE USE FOR
60-90 DEGREE

WILL NOT SLIDE TO 0 DEGREE
POSITION

WILL NOT GO BETWEEN 45-60
DEGREE